

robot coupe®



FOOD
PROCESSORS

DISCS

VEG PREP
MACHINES

CUTTER
MIXERS

ROBOT COOK®

BLIXER®

IMMERSION
BLENDERS

JUICE
EXTRACTORS

AUTOMATIC
SIEVES



**EXPORT
CATALOGUE**
02/2023

NEW PRODUCTS & FEATURES

robot coupe®

PAGE **40**

EASYCLEAN XPRESS

The zero waste solution to clean EXPERT dicing grids.



PAGE **128**

CMP COMPACT PRODUCT RANGE

New CMP even more robust with their new stainless steel motor bloc, the integrated lug on the motor base for better ergonomic, and also the new patented EasyPlug system meaning that the power cord can be easily replaced.



robot coupe®

INNOVATION AT THE HEART OF OUR HISTORY

Since 1961, Robot-Coupe has designed, developed and manufactured all its products in France, the home of gastronomy.



MORE THAN 60 YEARS OF INNOVATION

HUNDREDS OF EXCLUSIVE PATENTS

1961: 1st standing vegetable slicer
1966: 1st Vertical Cutter Mixer



1960 / 1970

1970 / 1980



1970: 1st Food Processor
1975: Ranges of Cutter Mixers and Food Processors

1980: 1st Blixer® - Blender Mixer
1986: 1st CL 50 Vegetable Preparation machine



1990 / 2000



1990: Range of Vegetable Preparation machines
1996: 1st Immersion Blender with removable foot

2000: Range of Immersion Blender
2008: 1st Automatic Juice Extractor



TODAY

2012: The 1st Professional Cooking Cutter Blender
2020: Launch of new Juice Extractor range and
13 new large-capacity table-top models of
Food Processors, Cutter Mixers and Blixer®.

All the latest Robot-Coupe® innovations are indicated with the  pictogram.

robot coupe®

WORLD LEADER PRESENT IN MORE THAN 130 COUNTRIES



LOCAL COMMITMENT FOR OVER 40 YEARS

Present in more than 130 countries, Robot-Coupe uses its expertise and know how as a world leader to constantly adapt to different types of local cuisine. Across the globe, our teams provide ongoing support to distributors and catering professionals to meet their specific needs.



A CULTURE OF COMMITMENT



DESIGNED AND MADE IN FRANCE

Robot-Coupe products are all designed and made in France to guarantee a superior level of quality and ensure unbeatable performance. Our products are always at the cutting edge of technology and excellence.

INNOVATIVE AND DURABLE

Because our goal is to meet your needs, innovation is our focus to anticipate your every requirement.

We commit to offering you high performance, durable products that exceed the current norms, with technical and industrial choices designed to guarantee the durability, maintenance and reparability of our products.



INSPIRING AND SATISFYING

Being your partner in the kitchen stimulates our research and development to imagine, improve and create new ways of utilising our products.

Your satisfaction is our priority to build a lasting relationship of trust and allow you to express your full culinary creativity.

robot coupe®

A COMPANY COMMITTED TO SUSTAINABLE DEVELOPMENT

Throughout the decades, Robot-Coupe has been committed to a policy of social and ethical responsibility with four points of focus.

“ Our **heavy duty** machines
are designed **to last** ”

“ We **go beyond the requirements** to guarantee
the **highest levels**
of performance ”



“ Our **partners are based in Europe**
and we support them in developing
a **sustainable approach** ”

“ **100%** of our machines
can be repaired and **more**
than 95% recyclable ”

STRONG COMMITMENTS THROUGHOUT THE SERVICE LIFE OF PRODUCTS

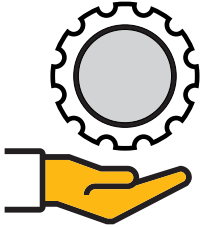

DESIGN

Products designed to last

- The materials used for our machines are high quality and long lasting.
- Our machines provide energy efficiency and savings throughout their service life.
- 100% of our products can be repaired.
- Spare parts are available for more than 10 years after a product is discontinued.

PRODUCTION

Ethical and responsible practice

- Compliance with the most stringent standards.
- Application of the ROHS directive (Restriction Of Hazardous Substances) and incorporation of future standards such as the EuP (Energy Using Product).
- The choice of European supply partners to reduce transport and its impact on the environment.

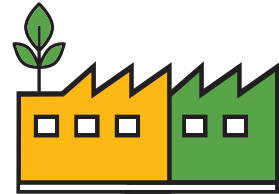

RESOURCES

Sustainable resource management:

- Reduction in packaging from design onwards and decrease in production waste.
- High precision machines to reduce waste in the kitchen.
- Our products are more than 95% recyclable.
- Participation in waste collection and recycling schemes in each country.



PEOPLE

A socially committed company:

- An individual employee development policy and promotion of ethics.
- Respect of International Labour Organisation standards.
- Sharing of our CSR requirements with our partners with corresponding support and backing.



robot coupe®

AT YOUR SERVICE

Robot-Coupe is not only a manufacturer. It is a people oriented company whose ability to listen and provide quality service is rolled out across the globe to improve the everyday lives of professionals. Our customers' requirements dictates our actions and our support.

PRESENCE IN THE FIELD

Robot-Coupe is at your side:

- Demonstration of the latest Robot-Coupe machines
- Audit of your kitchen equipment
- Technical training in your restaurant or in Robot-Coupe's kitchens
- Support for the repair and maintenance of your machines and replacement of spare parts
- Sharing of experience.



“ A **trusted partner** who brings me true **peace of mind** ”

Ask for a demonstration
on our website.
robot-coupe.com



TO IMPROVE USERS' DAILY LIFE

guides you in the use of your machine:



1 Scan the QR code of your machine



 **Easy Guide**

- 2 • Access your product page on robot-coupe.com and check out all the content that will make your life easier: videos on how to use, clean and maintain your machine, instructions for use and safety, recipes, etc.

A TRUSTED PARTNER



Quality Customer Service

Robot-Coupe has a dedicated team to answer all your questions and help you choose the right equipment including quotations, orders, invoice, shipping, etc. Guaranteed dispatch of machines and accessories within 48 hours. Spare parts ordered on our after sales service website are sent within 24 hours. More than 98% of orders meet the stipulated deadline.

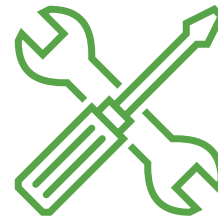

High tech assistance

To complete its service offering, Robot-Coupe has a specialised team trained to provide efficient, rapid help in troubleshooting, carrying out repairs and maintenance, providing video tutorials, etc.



A high performance logistics centre

Robot-Coupe keeps all its machine and spare parts stocks in a dedicated warehouse to ensure rapid delivery times. More than 90% of our references are kept in stock. A team of logistic professionals is tasked with carefully organising orders and ensuring traceability of shipments.



An efficient after sales service

The www.spareparts.uk.robot-coupe.com website provides a rapid tool to find information and or order:

- Consultation of spare parts with exploded views and wiring diagrams.
- Multicriteria searches by reference #, serial number, product category or model.
- Ordering of spare parts in real time*.

*For authorised dealers only

robot coupe®

IS AT YOUR SIDE

- | | | | | |
|--|--|---|--|--|
| 1 MIDI CATALOGUE
Export
Ref. 450 897 | 2 SELECTION GUIDE
Discs
Ref. 430 401 | 3 RECIPE BOOKS
Robot Cook®
Ref. 450 986 | 4 RECIPE BOOKS
Nutrition & Healthcare
Ref. 451 532 | 5 RECIPE BOOKS
Freshness & Vitamins
Ref. 451 738 |
|--|--|---|--|--|

Contact your Robot-Coupe Territory Manager to discover the full collection.



TRADE SHOWS AROUND THE WORLD



HOST / Milano - Italy
 GASTRO / Prague - Czech Republic

SIRHA / Budapest - Hungary
 FOODSERVICE / Santiago - Chile

GULFHOST / Dubai - UAE
 SIRAH / Lyon - France

NRA / Chicago, IL - USA
 PIR / Moscow - Russia

IN YOUR STORES AND SHOWROOMS



Set of 3 displays

Ref. 451 581

Dimensions: L126 x H60 x W40 cm

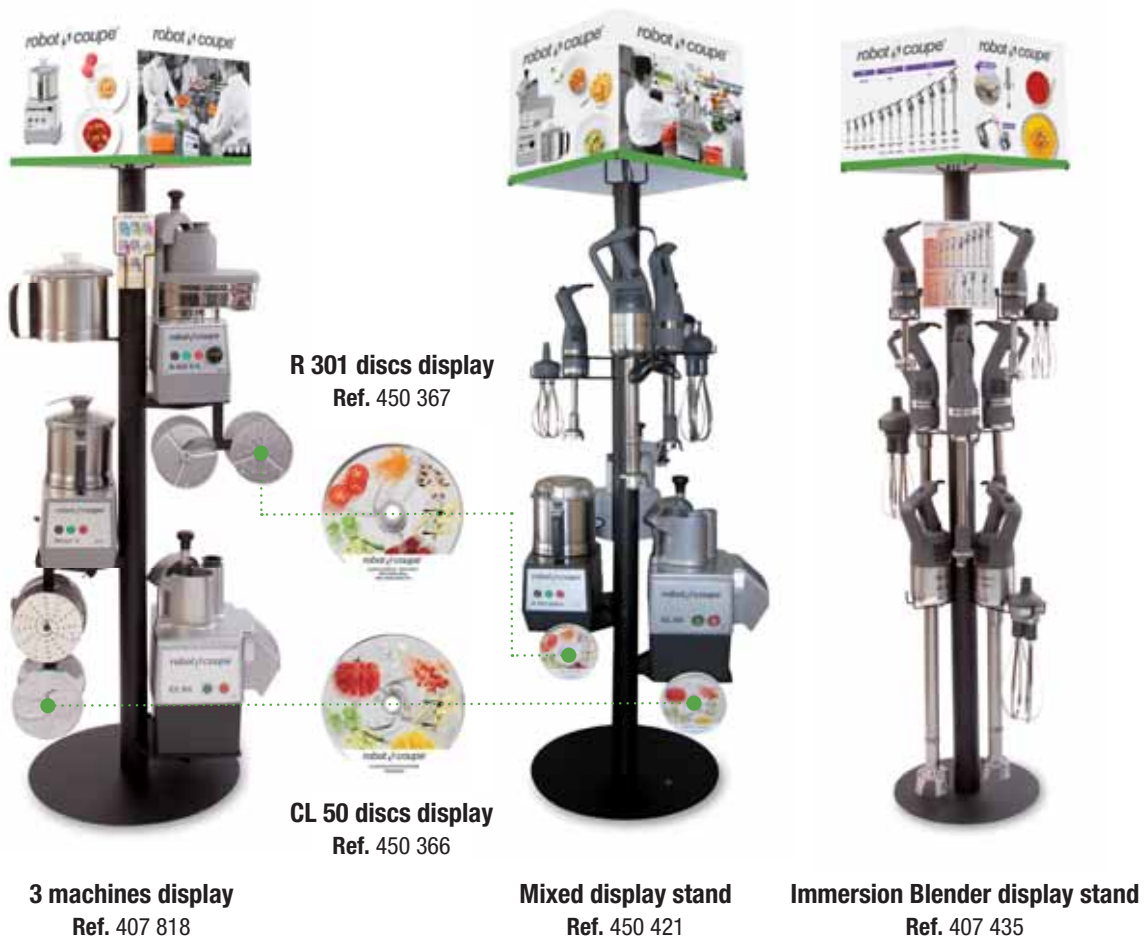

3 machines display
Ref. 407 818

R 301 discs display
Ref. 450 367

CL 50 discs display
Ref. 450 366

Mixed display stand
Ref. 450 421

Immersion Blender display stand
Ref. 407 435

robot coupe®

IS AT YOUR SIDE

FIND ALL OUR VIDEOS ON THE OFFICIAL ROBOT-COUPÉ CHANNEL:



Robot-Coupe R 301 Ultra video



Robot-Coupe CL 50 Ultra video



Robot-Coupe J 100 video

VIDEOS ALSO ON
robot-coupe.com

ON THE OFFICIAL ROBOT-COUPÉ SOCIAL MEDIA



LinkedIn
robot-coupe-official



Facebook
RobotCoupeOfficial



Youtube
Robot-Coupe Official



Instagram
robotcoupe_official

AND WITH OUR AFTER SALES SERVICE



Online support

To report non compliant orders , transport damage, or to request technical assistance.

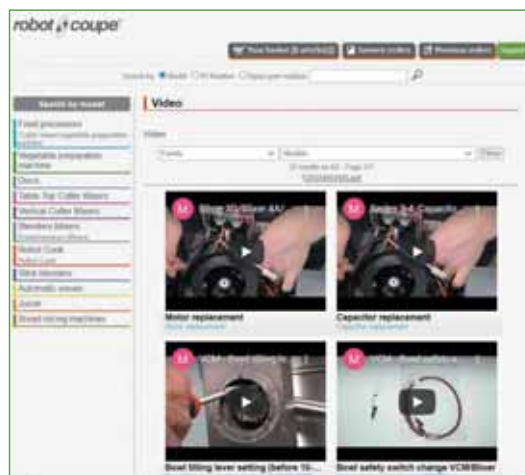

After Sales Service videos

To train your technicians on maintenance and repair operations.

A COMPREHENSIVE WEBSITE



NEW



NEW ROBOT-COUPÉ WEBSITE

- **Responsive design and user friendly:** easy access to information no matter your device (desktop computer, mobile, tablet)
- **Videos:** discover our products live and train yourself

FOR YOU, DEALERS AND KITCHEN PLANNERS



- **Dedicated access:** consult and download technical instructions, specifications, 2D, 3D & BIM drawings

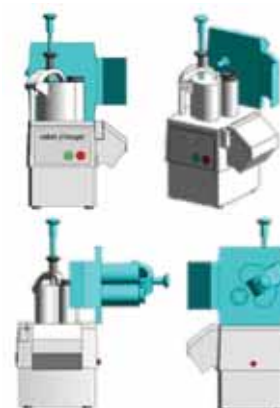

FOR YOUR CUSTOMERS

- **Selection guide:** find the right machine in just a few clicks
- **Product registration:** download user' manuals and safety instructions sheets

robot coupe[®]

SOLUTIONS FOR EVERY FOOD SECTOR

COMMERCIAL FOODSERVICE



FAST FOOD

- Fast Food
- Juice Bars
- Takeaway
- Salad & Sandwich Bars
- Cafeterias
- Food Courts



CONTRACT CATERING



CATERING FOR THE EDUCATIONAL SECTOR

- Day care
- Pre-school
- Primary school
- High school
- University
- Central kitchens



ARTISANS AND SUPERMARKETS



BAKERS AND CONFECTIONERS

- Bakers
- Confectioners
- Tea rooms
- Ice cream parlours
- Chocolate makers
- Pie shops



FULL SERVICE

Casual dining
Traditional restaurants
Theme restaurants
Chains
Bistro cuisine
Gourmet cuisine

HOTEL CATERING

All categories of hotels
Banquets
Holiday centres
Camping grounds
Staff canteens

COMMERCIAL FOODSERVICE



SOCIAL FOOD SERVICE

Company restaurants
Institutional restaurants
Mining Sites
Army
Prisons
Central kitchens

CATERING IN THE HEALTHCARE SECTOR

Retirement / Nursing Homes
Hospitals
Special needs facilities
Central kitchens

CONTRACT CATERING



DELICATESSEN CATERING

Delicatessens
Caterers

SUPERMARKETS

Freshly cut food
Greengrocers
Juice bars
Delicatessens
Snack bars
Food Courts



#THEsolution

robot 



MAKE LIFE EASIER FOR THE USER

Fewer manual tasks to take away the strain



SAVE TIME

Increase productivity

ULTRA FRESH JUICE
2L = 1min



HOMEMADE FRENCH FRIES
20kg = 4mins



CHOPPED VEGETABLE SALAD
10kg = 2mins



SOUP
45L = 6mins



MAYONNAISE
2L = 1min



COLESLAW
300kg = 1hr





SAVE MONEY

Return on investment in less than 6 months!

Examples:



Invest in a CL 50
= **Save** one hour of work a day.



Invest in a Robot Cook®
= **Save** 20 minutes per service.



BOOST YOUR CREATIVITY

Let your imagination run wild



SATISFY YOUR CUSTOMERS



FRESHNESS AND ORIGINS OF PRODUCT



HOMEMADE



LOCAL



SEASONAL PRODUCT

FOOD PROCESSORS

R 301 Ultra



VEGETABLE PREPARATION MACHINES

CL 50 Ultra



JUICE EXTRACTORS

J 80 Buffet



CONTENTS

FOOD PROCESSORS

PAGE 20

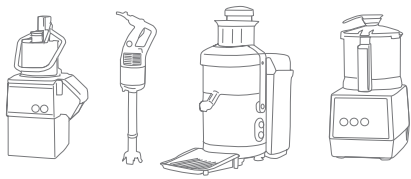

DISC COLLECTION

PAGE 36

VEGETABLE PREPARATION MACHINES

PAGE 52

CUTTER MIXERS

PAGE 76

ROBOT COOK[®]

PAGE 96

BLIXER[®]

PAGE 100

IMMERSION BLENDERS

PAGE 118

JUICE EXTRACTORS

PAGE 140

TECHNICAL DATA

(dimensions, weight, etc) PAGE 152

AUTOMATIC SIEVES

PAGE 147

FOOD PROCESSORS

CUTTER MIXERS & VEGETABLE SLICERS



2 MACHINES IN ONE!

Space saving and multifunctional, the Robot-Coupe Food Processor is one of the Chef's greatest allies even in a very small kitchen.

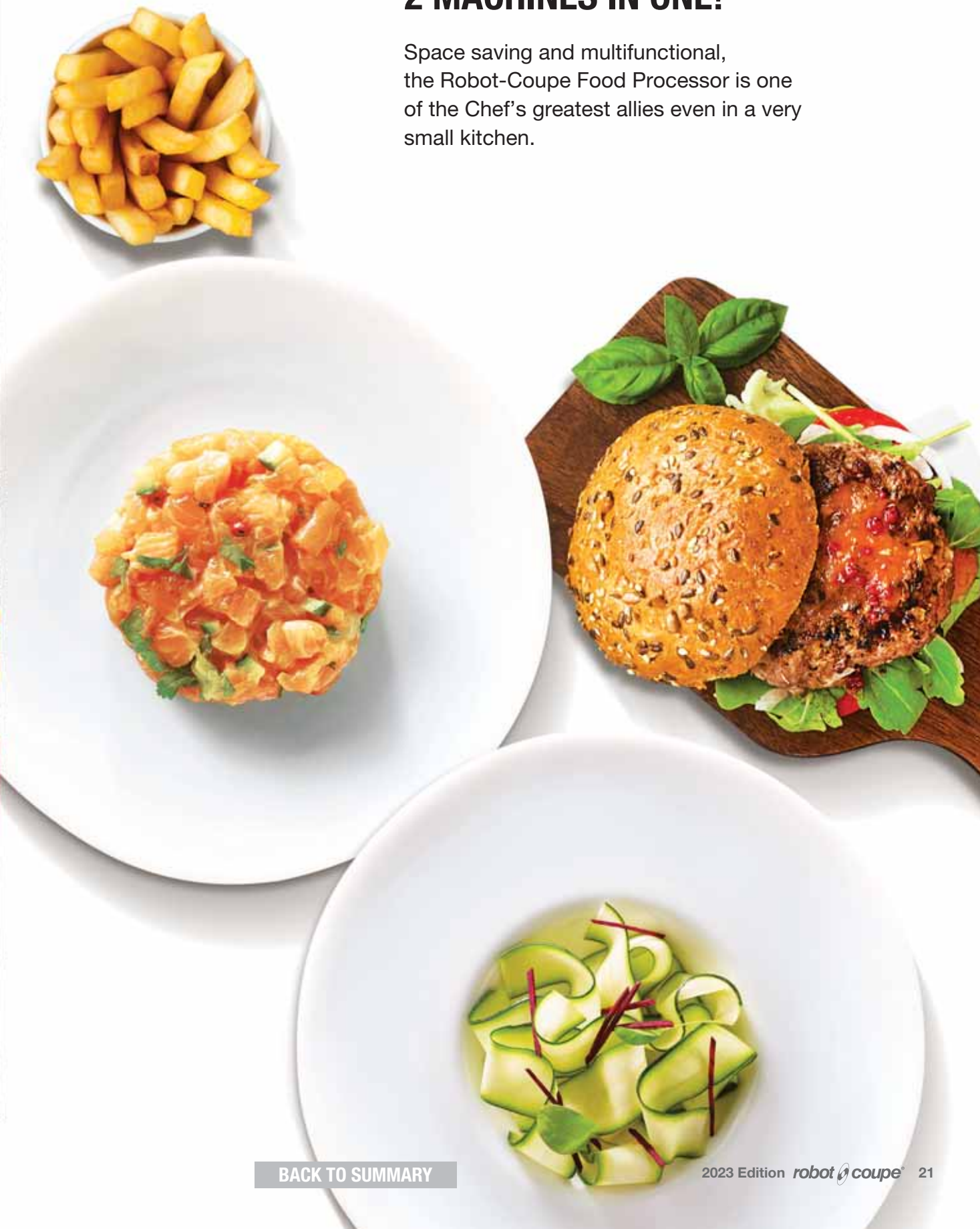

FOOD PROCESSORS

CUTTER MIXERS & VEGETABLE SLICERS

Lid:

Designed so that liquids and other ingredients can be added during processing.

Handle:

Ergonomic to make it easy to grasp the bowl.

Easy Guide

Variable speed:

300 to 3 500 rpm for a greater variety of applications.



Automatic restart by the pusher: faster and more convenient to operate.



Lateral ejection:

Space saving and ergonomic.



INNOVATION

Bowl-base twin-blade assembly

To process both large and small quantities. Coarse and fine serrated blade available as options.



Range of 28 discs available

as options.













Scan the QR Code to see the food processor in action.

CUTTER FUNCTION

	<p>Smooth blade Supplied as standard</p>				
			<p>COARSE CHOPPING</p>	<p>FINE CHOPPING</p>	<p>SAUCES, EMULSIONS</p>
	<p>Coarse serrated blade Designed for grinding & kneading</p>				
			<p>KNEADING</p>	<p>GRINDING</p>	
	<p>Fine serrated blade Designed for herbs & spices</p>				
			<p>CHOPPING HERBS</p>	<p>GRINDING SPICES</p>	

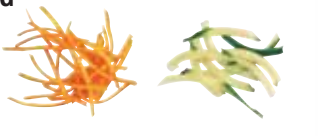
VEGETABLE PREPARATION FUNCTION

	<p>SLICING</p> 		<p>JULIENNE</p> 
	<p>RIPPLE CUT</p> 		<p>+ DICING*</p> 
	<p>GRATING</p> 		<p>+ FRENCH FRIES*</p> 

* For R 402, R 402 V.V, R 502, R 502 V.V, R 752, R 752 V.V.

Juice and Coulis Extraction Function*

- Extraction of fruit and vegetable juices for appetizers, sauces, sorbets, ice cream, smoothies, jam, fruit jellies, etc.
- Coulis function to extract pulp rich juices from cooked or tender fruit and vegetables.
- Citrus press function for all types of citrus fruits.



* Available for R 201 XL, R 201 XL Ultra, R 211 XL, R 211 XL Ultra, R 301, R 301 Ultra, R 401, R 402, R 402 V.V.



GRATING / SLICING / RIPPLE CUT / JULIENNE

R 201 XL Ultra



OPTIONAL
23
DISCS

OPTIONAL
3
BLADES

2.9 L

- Single phase
- 1 speed
- Internal ejection
- Juice Extractor Kit*

R 201 XL



OPTIONAL
23
DISCS

OPTIONAL
3
BLADES

2.9 L

- Single phase
- 1 speed
- Internal ejection
- Juice Extractor Kit*

R 211 XL Ultra



OPTIONAL
23
DISCS

OPTIONAL
3
BLADES

2.9 L

- Single phase
- 1 speed
- Juice Extractor Kit*

R 211 XL



OPTIONAL
23
DISCS

OPTIONAL
3
BLADES

2.9 L

- Single phase
- 1 speed
- Juice Extractor Kit*

R 301 Ultra



OPTIONAL
23
DISCS

OPTIONAL
3
BLADES

3.7 L

- Single phase
- 1 speed
- Juice Extractor Kit*

R 301



OPTIONAL
23
DISCS

OPTIONAL
3
BLADES

3.7 L

- Single phase
- 1 speed
- Juice Extractor Kit*



GRATING / SLICING / RIPPLE CUT / JULIENNE

+ DICING + FRENCH FRIES

R 402 V.V.



OPTIONAL
28
DISCS

OPTIONAL
3
BLADES

4.5 L

- Single phase
- Variable speed
- Juice Extractor Kit*

R 402



OPTIONAL
28
DISCS

OPTIONAL
3
BLADES

4.5 L

- Single phase or Three phase
- 2 speeds
- Juice Extractor Kit*

R 401



OPTIONAL
23
DISCS

OPTIONAL
3
BLADES

4.5 L

- Single phase
- 1 speed
- Juice Extractor Kit*

R 502 V.V.



OPTIONAL
50
DISCS

OPTIONAL
3
BLADES

5.9 L

- Single phase
- Variable speed
- R-Mix®
- Potato Ricer Attachment*

R 502



OPTIONAL
50
DISCS

OPTIONAL
3
BLADES

5.9 L

- Three phase
- 2 speeds
- Potato Ricer Attachment*

R 752 V.V.



OPTIONAL
50
DISCS

OPTIONAL
3
BLADES

7.5 L

- Single phase
- Variable speed
- R-Mix®
- Potato Ricer Equipment*

R 752



OPTIONAL
50
DISCS

OPTIONAL
3
BLADES

7.5 L

- Three phase
- 2 speeds
- Potato Ricer Equipment*

*Optional attachment

R-Mix®: Reverse rotation blending function

Models	Maximum quantity for cutter function	Hourly capacity for vegetable preparation function	Number of covers
R 201 XL / R 201 XL Ultra	1.0 kg	25 kg/hr	1 to 50
R 211 XL / R 211 XL Ultra	1.0 kg	40 kg/hr	1 to 50
R 301 / R 301 Ultra	1.5 kg	50 kg/hr	1 to 100
R 401 / R 402 / R 402 V.V.	2.5 kg	50 kg/hr	1 to 100
R 502 / R 502 V.V.	3.2 kg	150 kg/hr	50 to 300
R 752 / R 752 V.V.	3.8 kg	250 kg/hr	200 to 600



Area 87 cm²



Area 87 cm²



R 201 XL

Induction motor	✓
Power	550 W
Voltage	Single Phase
Speed	1 500 rpm
Pulse	✓
Cutter	2,9 L composite bowl with handle
Blade	Smooth Stainless steel blades - Included
Vegetable slicer	Half-moon hopper Cylindrical hopper Ø 58 mm
Ejection	In bowl
Discs	2 mm slicer, 2 mm grater - Included

R 201 XL Ultra

Induction motor	✓
Power	550 W
Voltage	Single Phase
Speed	1 500 rpm
Pulse	✓
Cutter	2,9 L stainless steel bowl with handle
Blade	Smooth Stainless steel blades - Included
Vegetable slicer	Half-moon hopper Cylindrical hopper Ø 58 mm
Ejection	In bowl
Discs	2 mm slicer, 2 mm grater - Included

Choose your model:



Scan the QR Code to see the Food Processors in action.

R 201 XL	Ref.
R 201 XL 230V/50/1 - 2 discs	22570
R 201 XL 230V/50/1 UK plug - 2 discs	22571
R 201 XL 220V/60/1 - 2 discs	22574
R 201 XL 120V/60/1 - 2 discs	22575

R 201 XL Ultra	Ref.
R 201 XL Ultra 230V/50/1 - 2 discs	22590
R 201 XL Ultra 230V/50/1 UK plug - 2 discs	22591
R 201 XL Ultra 220V/60/1 - 2 discs	22594
R 201 XL Ultra 120V/60/1 - 2 discs	22595

Complete disc collection page 38



Choose your options:



R 201 XL / R 201 XL Ultra		
Options	Ref.	
Coarse serrated blade Especially for grinding & kneading	27138	
Fine serrated blade Especially for herbs & spices	27061	
Additional smooth blade	27055	
Juice Extractor Kit	27393	
Citrus press attachment	27392	



R 211 XL

Induction motor	✓
Power	550 W
Voltage	Single Phase
Speed	1 500 rpm
Pulse	✓
Cutter	2,9 L composite bowl with handle
Blade	Smooth Stainless steel blades - Included
Vegetable slicer	Half-moon hopper Cylindrical hopper Ø 58 mm
Ejection	Continuous
Discs	Not included

Choose your model:

R 211 XL	Ref.
R 211 XL 230V/50/1	2129
R 211 XL 230V/50/1 UK plug	2196
R 211 XL 220V/60/1	2128
R 211 XL 120V/60/1	2127



R 211 XL Ultra

Induction motor	✓
Power	550 W
Voltage	Single Phase
Speed	1 500 rpm
Pulse	✓
Cutter	2,9 L stainless steel bowl with handle
Blade	Smooth Stainless steel blades - Included
Vegetable slicer	Half-moon hopper Cylindrical hopper Ø 58 mm
Ejection	Continuous
Discs	Not included

R 211 XL Ultra	Ref.
R 211 XL Ultra 230V/50/1	2122
R 211 XL Ultra 230V/50/1 UK plug	2197
R 211 XL Ultra 220V/60/1	2121
R 211 XL Ultra 120V/60/1	2120

Choose your pack of discs:

	Ref.
Pack of 5 discs	
Slicers 2 mm - 4 mm Grater 2 mm Julienne 4x4 mm - 8x8 mm	1946
Asia Pack of 4 discs	
Slicers 2 mm - 4 mm Grater 2 mm Julienne 2x2 mm	1904
Eastern Europe Pack of 3 discs	
Slicers 2 mm Grater 2 mm Julienne 4x4 mm	2006

Complete disc collection page 38



Choose your options:



Options	Ref.
Coarse serrated blade Especially for grinding & kneading	27138
Fine serrated blade Especially for herbs & spices	27061
Additional smooth blade	27055
Juice Extractor Kit	27393
Citrus press attachment	27392

Juice and Coulis EXTRACTOR KIT

- Extraction of fruit and vegetable juices for appetizers, sauces, sorbets, ice cream, smoothies, jam, fruit jellies, etc.
- Coulis function to extract pulp rich juices from cooked or tender fruit and vegetables.
- Citrus press function for all types of citrus fruits.
- Replaces numerous manual tools:

COULIS FUNCTION



CITRUS PRESS FUNCTION



Large capacity hopper
75 x 90 mm



Scan the QR Code
to see this function
in action.



RASPBERRY COULIS
FOR SORBETS



COULIS
FOR APPETIZERS



COCONUT MILK



LEMON JUICE



LEMON TART



ORANGE JUICE



	Ref.
Juice Extractor Kit for R 201 XL / R 201 XL Ultra / R 211 XL / R 211 XL Ultra	27393
Juice Extractor Kit for R 301 / R 301 Ultra / R 401 / R 402 / R 402 V.V.	27396
Citrus fruit attachment R 201 XL / R 201 XL Ultra / R 211 XL / R 211 XL Ultra	27392
Citrus fruit attachment for R 301 / R 301 Ultra / R 401 / R 402 / R 402 V.V.	27395



R 301

Induction motor	✓
Power	650 W
Voltage	Single phase
Speed	1 500 rpm
Pulse	✓
Cutter	3.7 L composite bowl
Blade	Stainless steel smooth blade - Included
Vegetable slicer	Half moon hopper 1.6 L Cylindrical hopper Ø 58 mm
Discs	Not included

Choose your model:



Scan the QR Code to see the Food Processors in action.

Choose your pack of discs:

R 301	Ref.
R 301 230V/50/1	2525
R 301 230V/50/1 UK plug	2446
R 301 230V/50/1 DK	2527
R 301 220V/60/1	2537
R 301 120V/60/1	2528



R 301 Ultra

Induction motor	✓
Power	650 W
Voltage	Single phase
Speed	1 500 rpm
Pulse	✓
Cutter	3.7 L stainless steel bowl
Blade	Stainless steel smooth blade - Included
Vegetable slicer	Half moon hopper 1.6 L Cylindrical hopper Ø 58 mm
Discs	Not included

R 301 Ultra	Ref.
R 301 Ultra 230V/50/1	2547
R 301 Ultra 230V/50/1 UK plug	2447
R 301 Ultra 230V/50/1 DK	2550
R 301 Ultra 220V/60/1	2543
R 301 Ultra 120V/60/1	2541

			Ref.
Pack of 5 discs			
Slicers 2 mm - 4 mm	Grater 2 mm	Julienne 4x4 mm - 8x8 mm	1946
Asia Pack of 4 discs			
Slicers 2 mm - 4 mm	Grater 2 mm	Julienne 2x2 mm	1904
Eastern Europe Pack of 3 discs			
Slicers 2 mm	Grater 2 mm	Julienne 4x4 mm	2006

Complete disc collection page 38



Choose your options:



	R 301		R 301 Ultra	
Options	Ref.		Ref.	
Coarse serrated blade Especially for grinding & kneading	27288		27288	
Fine serrated blade Especially for herbs & spices	27287		27287	
Additional smooth blade	27286		27286	
Cutter accessory (bowl, lid, blade)	27272		27278	
Juice Extractor Kit	27396		27396	
Citrus press attachment	27395		27395	

FOOD PROCESSORS CUTTER MIXERS & VEGETABLE SLICERS



R 401

Induction motor	✓
Power	700 W
Voltage	Single phase
Speed	1 500 rpm
Pulse	✓
Motor Base	Metal
Cutter	4.5 L stainless steel bowl
Blade	Stainless steel smooth blade - Included
Vegetable slicer	Half moon hopper 1.6 L Cylindrical hopper Ø 58 mm Stainless steel bowl
D-Clean Kit	-
Discs	Not included

Choose your model:



Scan the QR Code to see the Food Processors in action.

R 401	Ref.
R 401 230V/50/1	2425
R 401 230V/50/1 UK plug	2449
R 401 220V/60/1	2429
R 401 120V/60/1	2426



R 402

Induction motor	✓	
Power	750 W	
Voltage	Three phase	Single Phase
Speed	750 / 1 500 rpm	500 / 1 500 rpm
Pulse	✓	
Motor Base	Metal	
Cutter	4.5 L stainless steel bowl	
Blade	Stainless steel smooth blade - Included	
Vegetable slicer	Half moon hopper 1.6 L Cylindrical hopper Ø 58 mm Stainless steel bowl	
D-Clean Kit	-	
Discs	Not included	

R 402 - Three phase	Ref.
R 402 400V/50/3	2433
R 402 380V/60/3	2435
R 402 230V/50/3	2432
R 402 220V/60/3	2434

R 402 - Single phase	Ref.
R 402 230V/50/1	2453
R 402 230V/50/1 UK plug	2454
R 402 120V/60/1	2459

Choose your pack of discs:

	Ref.
Pack of 5 discs	
Slicers 2 mm - 4 mm	
Grater 2 mm	
Julienne 4x4 mm - 8x8 mm	1946
Asia Pack of 4 discs	
Slicers 2 mm - 4 mm	
Grater 2 mm	
Julienne 2x2 mm	1904
Asia Pack of 6 discs for R 402 and R 402 V.V. only	
Slicers 2 mm - 4 mm	
Grater 2 mm	
Julienne 2x2 mm	
Dicing Equipment 10x10x10 mm	2195
Eastern Europe Pack of 3 discs	
Slicers 2 mm	
Grater 2 mm	
Julienne 4x4 mm	2006

Complete disc collection page 38



Choose your options:



Options	Ref.
Coarse serrated blade Especially for grinding & kneading	27346
Fine serrated blade Especially for herbs & spices	27345
Additional smooth blade	27344
Cutter accessory (bowl, lid, blade)	27342
Juice Extractor Kit	27396
Citrus press attachment	27395



Area 104 cm²
 "Discover all the disk packs on page 41"

R 402 V.V.

Induction motor	✓
Power	1 000 W
Voltage	Single phase
Speed	300 to 3 500 rpm for cutter 300 to 1 000 rpm for vegetable slicer
Pulse	✓
Motor Base	Metal
Cutter	4.5 L stainless steel bowl
Blade	Stainless steel smooth blade - Included
Vegetable slicer	Half moon hopper 1.6 L Cylindrical hopper Ø 58 mm Stainless steel bowl
D-Clean Kit	Included
Discs	Not included

Choose your model:

	R 402 V.V.	Ref.
R 402 V.V. 230V/50-60/1		2444
R 402 V.V. 230V/50/1 UK plug		2478

				Ref.
Pack of 5 discs				
Slicers 2 mm - 4 mm	Grater 2 mm	Julienne 4x4 mm - 8x8 mm		1946
Asia Pack of 4 discs				
Slicers 2 mm - 4 mm	Grater 2 mm	Julienne 2x2 mm		1904
Asia Pack of 6 discs for R 402 and R 402 V.V. only				
Slicers 2 mm - 4 mm	Grater 2 mm	Julienne 2x2 mm	Dicing Equipment 10x10x10 mm	2195
Eastern Europe Pack of 3 discs				
Slicers 2 mm	Grater 2 mm	Julienne 4x4 mm		2006

Complete disc collection page 38



	R 402 V.V.
Options	Ref.
Coarse serrated blade Especially for grinding & kneading	27346
Fine serrated blade Especially for herbs & spices	27345
Additional smooth blade	27344
Cutter accessory (bowl, lid, blade)	27342
Juice Extractor Kit	27396
Citrus press attachment	27395





POTATO RICER

MODELS R 502, R 502 V.V., R 752, R 752 V.V.



Scan the QR-Code to see the mashed potato function in action.



Potato Ricer Attachment



Feed hopper
(R 502 and R 502 V.V. only)

1



Paddle
Puree grid:
3 mm or 6 mm
Special ejection disc

Potato Ricer Equipment

2

The Potato Ricer Attachment consists of:

- a feed hopper to handle large quantities of potatoes (for R 502 and R 502 V.V. only)
- a paddle
- a special Ø 3 mm or 6 mm grid
- a special puree ejection disc.



		Ref.
Potato Ricer Attachment Ø 3 mm (R 502 and R 502 V.V.)	1 + 2	28207
Potato Ricer Equipment Ø 3 mm	2	28208
Potato Ricer Attachment Ø 6 mm (R 502 and R 502 V.V.)	1 + 2	28209
Potato Ricer Equipment Ø 6 mm	2	28210



R 502

Induction motor	✓
Power	900 W
Voltage	Three phase
Speed	750 rpm - 1 500 rpm
Pulse	✓
Motor base	Metal
Cutter	5.9 L stainless steel bowl
Scraper arm	✓
Blade	Stainless steel smooth blade - Included Blade cleaning tool - Included, coming soon
Vegetable slicer	Half moon hopper 2.2 L Cylindrical hopper Ø 58 mm and Ø 39 mm, Exactitube pusher - Included
D-Clean Kit	Included
Discs	Not included

Choose your model:	R 502	Ref.
R 502 400V/50/3		2382
R 502 380V/60/3		2381
R 502 220V/60/3		2384

Choose your pack of discs:

	Ref.
Pack of 8 discs for Restaurants	
Slicers 2 mm - 5 mm Grater 2 mm Julienne 3x3 mm Dicing Equipment 10x10x10 mm French Fries Equipment 10x10x10 mm Wall disc holder	1933W
Pack of 12 discs for Institutions	
Slicers 2 mm - 5 mm Grater 2 mm - 5 mm Julienne 3x3 mm - 4x4 mm Dicing Equipment 10x10x10 mm - 20x20x20 mm French Fries Equipment 10x10x10 mm Wall disc holder x2	1942W
Asia Pack of 7 discs	
Slicers 2 mm - 5 mm Grater 2 mm Julienne 2x2 mm - 3x3 mm Dicing Equipment 10x10x10 mm Wall disc holder	2023W
Eastern Europe Pack of 5 discs	
Slicers 2 mm Grater 2 mm Julienne 4x4 mm Dicing Equipment 10x10x10 mm	2005W

Complete disc collection page 38



Choose your options:



	R 502 all models	
Options	Ref.	
Coarse serrated blade Especially for grinding & kneading	27305	
Fine serrated blade Especially for herbs & spices	27304	
Additional smooth blade	27303	
Cutter accessory (bowl, lid, blade)	27320	
Blade cleaning tool - Coming soon	49258	



R 502 V.V.

Induction motor	✓
Power	1 500 W
Voltage	Single phase
Speed	300 to 3 500 rpm for cutter 300 to 1 000 rpm for vegetable slicer
Pulse	✓
Motor base	Metal
Cutter	5.9 L stainless steel bowl
Scraper arm	✓
Blade	Stainless steel smooth blade - Included Blade cleaning tool - Included, coming soon
Vegetable slicer	Half moon hopper 2.2 L Cylindrical hopper Ø 58 mm and Ø 39 mm, Exactitube pusher - Included
D-Clean Kit	Included
Discs	Not included

Choose your model:	R 502 V.V.	Ref.
R 502 V.V. 230V/50-60/1		2390
R 502 V.V. 230V/50-60/1 UK plug		2389

NEW

R 752 AND R 752 V.V. FOOD PROCESSORS

- Multi-purpose, space-saving and high-performance thanks to their greater processing capacity
- A timer for greater convenience
- New attachments especially designed for professional needs!

Adjustable hopper to suit all size fruit and vegetables!



- Requires less effort
- Prevents MSD
- Takes away the tediousness



Extra large hopper:
Up to 15 tomatoes or 1 whole cabbage.



Cylindrical hopper
Ø 58 mm: For uniform cutting of long vegetables.



Exactitube pusher:
Cylindrical hopper with Ø 39 mm Exactitube pusher to cut up small fruit and vegetables such as chillis, gherkins, dry sausage, asparagus, spring onions, bananas, strawberries, grapes, etc.

INNOVATION

Extra ergonomic:
Lever with assisted movement = less effort for the operator.

Timer:
Less effort, greater precision and more regular results no matter what the recipe.

Easy Guide

Motor power:
Ideal for demanding preparations.

Lateral ejection:
Space saving and convenient to use.

Lid:
Liquids and other ingredients can be adding during processing.



Scraper arm:
Designed to easily scrape the lid and edges of the bowl without stopping the machine.

7.5 L large capacity bowl with ergonomic handle:
Saves time by increasing the quantities processed.*



Delivered with all stainless steel smooth blade: 2 detachable adjustable blades.



Range of more than 50 discs available as options.

Options for R 752 & R 752 V.V.	Ref.
Coarse serrated blade <i>Designed for grinding & kneading</i>	27308
Fine serrated blade <i>Designed for herbs & spices</i>	27307
Additional stainless steel smooth blade	27306
Cutter accessory (bowl, lid, blade)	27318
Lower coarse serrated blade	49162
Upper coarse serrated blade	49163
Lower fine serrated blade	49164
Upper fine serrated blade	49165
Lower smooth blade	49160
Upper smooth blade	49161
3 mm Potato Ricer Equipment	28208
6 mm Potato Ricer Equipment	28210
Motor shaft brush - <i>Coming soon</i>	49257

*5.9 L bowl for R 502 / R 502 V.V. and 7.5 L for R 752 / R 752 V.V.

BACK TO SUMMARY



R 752

Induction motor ✓
 Power 1 800 W
 Voltage Three phase
 Speed 750 rpm - 1 500 rpm

Pulse ✓
 Motor base Metal
 Cutter 7.5 L stainless steel bowl
 Scraper arm ✓

Blade All stainless steel detachable, adjustable smooth blade - **Included**

Accessories Motor shaft brush - **Included, coming soon**
 Vegetable slicer Full moon hopper 4.4 L
 Cylindrical hopper Ø 58 mm and Ø 39 mm,
 Exactitube pusher - **Included**

D-Clean Kit **Included**

Discs Not included

Choose your model:

	R 752	Ref.
R 752 400V/50/3		2113
R 752 380/60/3		2110
R 752 220/60/3		2108

Choose your pack of discs:

Choose your options opposite:

						Ref.
Pack of 8 discs for Restaurants						
Slicers 2 mm - 5 mm	Grater 2 mm	Julienne 3x3 mm	Dicing Equipment 10x10x10 mm	French Fries Equipment 10x10x10 mm	Wall disc holder	1933W
Pack of 12 discs for Institutions						
Slicers 2 mm - 5 mm	Grater 2 mm - 5 mm	Julienne 3x3 mm - 4x4 mm	Dicing Equipment 10x10x10 mm - 20x20x20 mm	French Fries Equipment 10x10x10 mm	Wall disc holder x2	1942W
Asia Pack of 7 discs						
Slicers 2 mm - 5 mm	Grater 2 mm	Julienne 2x2 mm - 3x3 mm	Dicing Equipment 10x10x10 mm	Wall disc holder		2023W
Eastern Europe Pack of 5 discs						
Slicers 2 mm	Grater 2 mm	Julienne 4x4 mm	Dicing Equipment 10x10x10 mm			2005W

Complete disc collection page 38



BACK TO SUMMARY



R 752 V.V.

Induction motor ✓
 Power 1 500 W
 Voltage Single phase
 Speed 300 to 3 500 rpm for cutter
 300 to 1 000 rpm for vegetable slicer

Pulse ✓
 Motor base Metal
 Cutter 7.5 L stainless steel bowl
 Scraper arm ✓

Blade All stainless steel detachable, adjustable smooth blade - **Included**

Accessories Motor shaft brush - **Included, coming soon**
 Vegetable slicer Full moon hopper 4.4 L
 Cylindrical hopper Ø 58 mm and Ø 39 mm,
 Exactitube pusher - **Included**

D-Clean Kit **Included**

Discs Not included

Choose your model:

	R 752 V.V.	Ref.
R 752 V.V. 230V/50-60/1		2115
R 752 V.V. 230V/50-60/1 UK plug		2080

DISC COLLECTION



THE WIDEST RANGE OF CUTS

More than 50 discs to choose from to slice, grate, julienne, dice, chop, shred, waffle cut and cut French fries with perfection in next to no time. Save hours of work each day using Robot-Coupe Food Processors and Vegetable Preparation Machines.

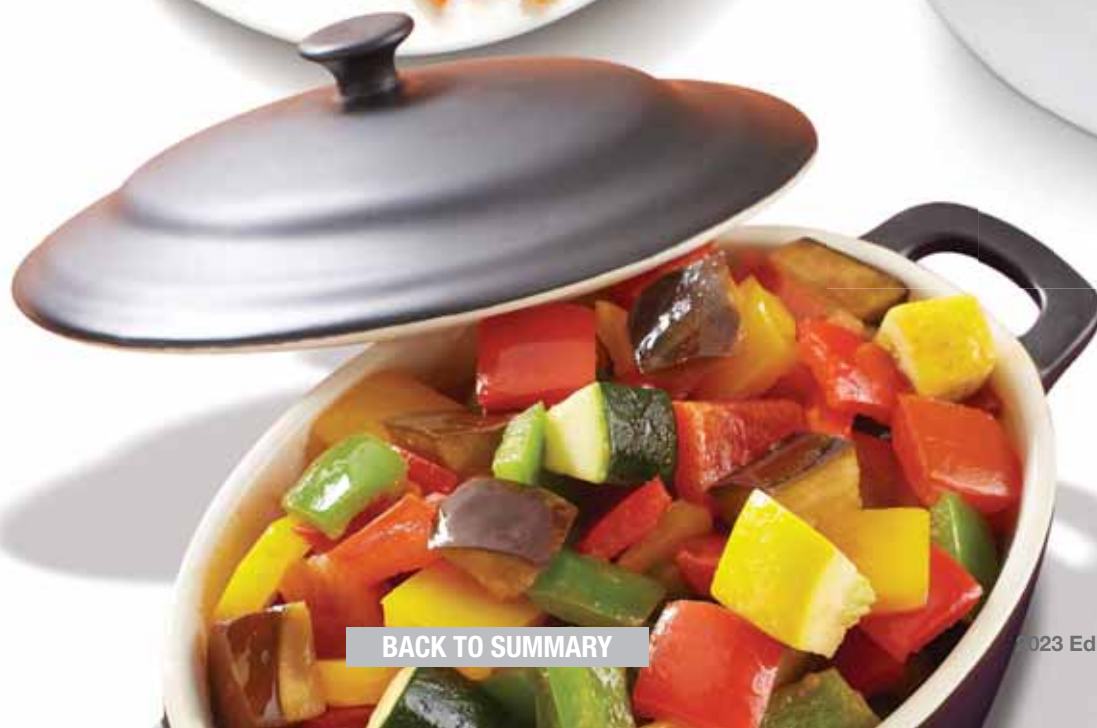

DISC COLLECTION



ESSENTIAL - Series 1-4





R 201 XL R 201 XL Ultra R 211 XL R 211 XL Ultra R 301 R 301 Ultra R 401 CL 20	R 402 R 402 V.V.	CL 40
--	---------------------	-------



EXPERT - Series 5-7

R 502/R 502 V.V. R 752/R 752 V.V.	CL 50 Gourmet
CL 50/CL 50 Ultra CL 52/CL 55 CL 60	

DISCS

	ESSENTIAL - Series 1-4	ESSENTIAL - Series 1-4	EXPERT - Series 5-7	EXPERT - Series 5-7	EXPERT - Series 5-7	
SLICERS 			Almonds 0.6 mm	28166W	28166W	
			0.8 mm	28069W	28069W	
	27051	27051	1 mm	28062W	28062W	
	27555	27555	2 mm	28063W	28063W	
	27086	27086	3 mm	28064W	28064W	
	27566	27566	4 mm	28004W	28004W	
	27087	27087	5 mm	28065W	28065W	
	27786	27786	6 mm	28196W	28196W	
			8 mm	28066W	28066W	
			10 mm	28067W	28067W	
			14 mm	28068W		
			4 mm cooked potatoes	27244W	27244W	
		6 mm cooked potatoes	27245W	27245W		
RIPPLE CUT 	27621	27621	2 mm	27068W	27068W	
			3 mm	27069W	27069W	
			5 mm	27070W	27070W	
GRATERS 	27588	27588	27148	1.5 mm	28056W	28056W
	27577	27577	27149	2 mm	28057W	28057W
	27511	27511	27150	3 mm	28058W	28058W
				4 mm	28073W	28073W
	27046	27046		5 mm	28059W	28059W
				6 mm		
	27632	27632		7 mm	28016W	28016W
	27764	27764		9 mm	28060W	28060W
	27191	27191		Parmesan cheese	28061W	28061W
				Röstis potatoes	27164W	27164W
				Raw potatoes	27219W	27219W
	27078	27078		0.7 mm horseradish paste		
	27079	27079		1 mm horseradish paste	28055W	28055W
27130	27130		1.3 mm horseradish paste			
JULIENNE 			1 x 8 mm (ribbons)	28172W	28172W	
			1 x 26 onion/cabbage	28153W	28153W	
	27080	27080	2 x 4 mm	27072W	27072W	
	27081	27081	2 x 6 mm	27066W	27066W	
			2 x 8 mm	27067W	27067W	
			2 x 10 mm (ribbons)	28173W	28173W	
	27599	27599	2 x 2 mm	28051W	28051W	
			2.5 x 2.5 mm	28195W	28195W	
			3 x 3 mm	28101W	28101W	
	27047	27047	4 x 4 mm	28052W	28052W	
	27610	27610	6 x 6 mm	28053W	28053W	
	27048	27048	8 x 8 mm	28054W	28054W	



ESSENTIAL - Series 1-4

R 211 XL R 211 XL Ultra R 301 R 301 Ultra R 401	R 402 R 402 V.V.	CL 40
CL 20		

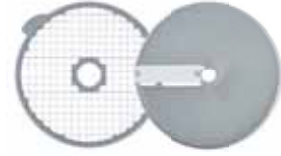

EXPERT - Series 5-7

R 502/R 502 V.V. R 752/R 752 V.V.	CL 50 CL 50 Ultra CL 52/CL 55 CL 60	CL 50 Gourmet
--------------------------------------	--	------------------

DISCS

DICING EQUIPMENT



FRENCH FRIES



BRUNOISE CL 50 Gourmet



WAFFLE CUTS CL 50 Gourmet



PACK OF DISCS

	ESSENTIAL - Series 1-4	ESSENTIAL - Series 1-4	ESSENTIAL - Series 1-4	DISCS	EXPERT - Series 5-7	EXPERT - Series 5-7
		■ 27113		5 x 5 x 5 mm	■ 28110W	■ 28110W
		■ 27114		8 x 8 x 8 mm	■ 28111W	■ 28111W
		■ 27298		10 x 10 x 10 mm	■ 28112W	■ 28112W
				12 x 12 x 12 mm	■ 28197W	
				14 x 14 x 5 mm (mozzarella)	■ 28181W	■ 28181W
				14 x 14 x 10 mm	■ 28179W	■ 28179W
				14 x 14 x 14 mm	■ 28113W	
				20 x 20 x 20 mm	■ 28114W	
				25 x 25 x 25 mm	■ 28115W	
				50 x 70 x 25 mm (salad)	■ 28180W	
		▲ 27116		8 x 8 mm	▲ 28134W	▲ 28134W
				8 x 16 mm	▲ 28159W	▲ 28159W
		▲ 27117		10 x 10 mm	▲ 28135W	▲ 28135W
				10 x 16 mm	▲ 28158W	▲ 28158W
				2 x 2 x 2 mm		28174W
				3 x 3 x 3 mm		28175W
				4 x 4 x 4 mm		28176W
				2 mm		28198W
				3 mm		28199W
				4 mm		28177W
				6 mm		28178W
	2006	2006	-	Pack of 3 discs		
	1904	1904	-	Pack of 4 discs		
	1946	1946	-	Pack of 5 discs		
		2195	1945	Pack of 6 discs		
		-	1909	Pack of 8 discs		
				Pack of 7 discs	2023W	2023W
				Pack of 8 discs	1933W	1933W
				Pack of 5 discs	2005W	2005W
				Pack of 12 discs	1942W	1942W
				Pack of 16 discs	2022W	2022W

■ DICING equipment consisting of: 1 dicing grid + 1 slicing disc.

▲ FRENCH FRIES equipment consisting of: 1 french fries grid + 1 special french fries cutting disk.

DISC COLLECTION
ACCESSORIES

NEW

EasyClean Xpress

The zero waste solution to clean EXPERT dicing grids R 502 to R 752 and CL 50 to CL 60

- Fast, easy cleaning
- Zero waste

For dicing grids	Ref.
8 mm	49305
10 mm	49309
12 mm	49313
14 mm	49314



NEW

D-CLEAN KIT

Dicing grid cleaning tool



Grid holder

- Essential R 402 - CL 40
- Expert R 502 to R 752 - CL 50 to CL 60

	Ref.
D-Clean Kit	29246

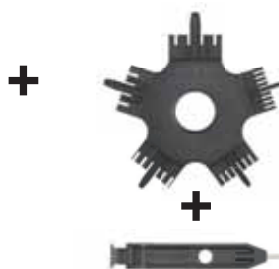

Dicing grid cleaning tool

- 5 mm, 8 mm, 10 mm, 12 mm and 14 mm

Scraper tool

WALL MOUNTED BLADE AND DISC HOLDER:

- 1 BLADE and 8 DISCS
- > R 201 XL Ultra to R 402 V.V.

Ref.
107810



WALL MOUNTED DISC HOLDER WITH 4 STAINLESS STEEL HOOKS:

- > 16 small discs or 8 large discs

Ref.
107812



DISC RACK:

- > R 502 to R 752 V.V.
- > CL 50 to CL 60

Ref.
27258



WALL MOUNTED DISC HOLDER STAINLESS STEEL

Ref.
101230



DISC PROTECTOR:

- > R 502 to R 752 V.V.
- > CL 50 to CL 60

Ref.
39726



MINI BOWL

- > EXPERT range from R 502 to R 752 V.V. and CL 50 to CL 60
- > Not compatible with dicing and French fries equipment.

Ref.
39716



THE TURNKEY SOLUTION FOR ALL KITCHENS

ESSENTIAL Series 1-4

EASTERN EUROPE PACK OF 3 DISCS

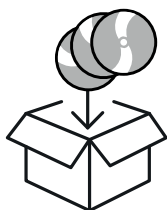

Slicers
2 mm

Graters
2 mm

Julienne
4 x 4 mm

Ref.	
R 211 XL, R 211 XL Ultra, R 301, R 301 Ultra, R 401, R 402, R 402 V.V., CL 20	2006

Wall-mounted disc holders (set of 2) **FREE**

ASIA PACK OF 4 DISCS

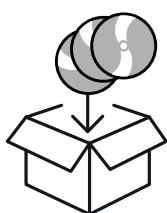

Slicers
2 mm & 4 mm

Graters
2 mm

Julienne
2 x 2 mm

Ref.	
R 211 XL, R 211 XL Ultra, R 301, R 301 Ultra, R 401, R 402, R 402 V.V., CL 20	1904

Wall-mounted disc holders (set of 2) **FREE**

PACK OF 5 DISCS

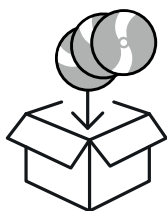

Slicers
2 mm & 4 mm

Graters
2 mm

Julienne
4 x 4 mm & 8 x 8 mm

Ref.	
R 211 XL, R 211 XL Ultra, R 301, R 301 Ultra, R 401, R 402, R 402 V.V., CL 20	1946

Wall-mounted disc holders (set of 2) **FREE**

PACK OF 6 DISCS

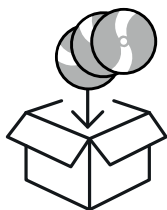

Slicers
2 mm & 4 mm

Graters
2 mm

Julienne
2 x 2 mm* & 4 x 4 mm**

Dicing Equipment
10 x 10 x 10 mm

Ref.	
R 402 & R 402 V.V.	2195
CL 40	1945

Wall-mounted disc holders (set of 2) **FREE**

*with 2195 / **with 1945

PACK OF 8 DISCS

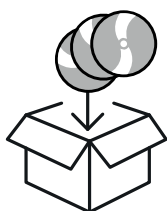

Slicers
2 mm & 4 mm

Graters
2 mm

Julienne
2 x 2 mm & 2 x 4 mm & 4 x 4 mm

Dicing Equipment
10 x 10 x 10 mm

Ref.	
CL 40	1909

Wall-mounted disc holders (set of 2) **FREE**

EXPERT Series 5-7

EASTERN EUROPE PACK OF 5 DISCS

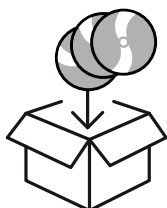

Slicers
2 mm

Graters
2 mm

Julienne
4 x 4 mm

Dicing Equipment
10 x 10 x 10 mm



Ref.		
Pack of 5 discs	2005W	

Wall-mounted disc holders (set of 2) **FREE**

ASIA PACK OF 7 DISCS

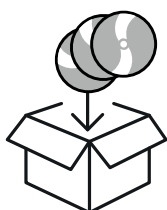

Slicers
2 mm & 5 mm

Graters
2 mm

Julienne
2 x 2 mm & 3 x 3 mm

Dicing Equipment
10 x 10 x 10 mm



Ref.		
Pack of 7 discs	2023W	

Wall-mounted disc holders (set of 2) **FREE**

PACK OF 8 DISCS - RESTAURANTS

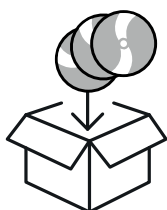

Slicers
2 mm & 5 mm

Graters
2 mm

Julienne
3 x 3 mm

Dicing Equipment
10 x 10 x 10 mm

French Fries Equipment
10 x 10 mm

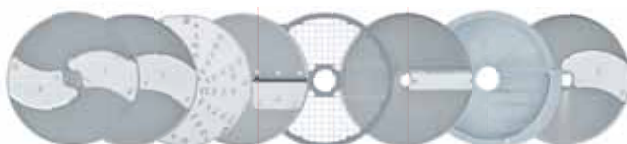

Ref.		
Pack of 8 discs	1933W	

Wall-mounted disc holders (set of 2) **FREE**

PACK OF 12 DISCS FOR INSTITUTIONS

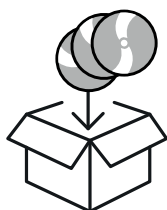

Slicers
2 mm & 5 mm

Graters
2 mm & 5 mm

Julienne
3 x 3 mm, & 4 x 4 mm



Dicing Equipment
10 x 10 x 10 mm & 20 x 20 x 20 mm

French Fries Equipment
10 x 10 mm

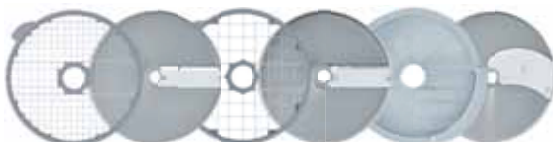

Ref.		
Pack of 12 discs	1942W	

Wall-mounted disc holders (set of 2) **FREE**

EXPERT Series 5-7

MULTICUT PACK OF 16 DISCS

Fruit and vegetables in all shapes and sizes

With evolving nutritional requirements, Chefs in the mass catering sector are looking for solutions to serve more fruit and raw vegetables.

The aim is to improve the nutritional quality of meals served in school canteens, company cafeterias and healthcare institutions. It is a great opportunity for Chefs to provide creative and original cuts to present fresh fruit and vegetables in a more attractive way.

Robot-Coupe is innovating with its latest launch, the Workstation Solution Pack, with 16 discs included.

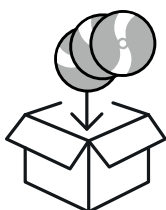

Slicers

1 mm, 2 mm, 4 mm

Graters

1.5 mm, 3 mm

Julienne

2.5 x 2.5 mm, 2 x 10 mm, 4 x 4 mm



Dicing Equipment

5 x 5 x 5 mm, 10 x 10 x 10 mm,
20 x 20 x 20 mm

French Fries Equipment

10 x 10 mm



Ref.	
MultiCut Pack of 16 discs	2022W

2 wall-mounted disc holders (set of 2) **FREE**



Scan the QR Code
to see this function
in action.

NEW

Surface treatment:

Mineral+[®]



High Resistance

This mineral-based treatment provides optimum protection of the disc surface.



Freshness is preserved

This treatment reduces friction on the disc, ensures perfect cutting and keeps fruit and vegetables fresh.



Easy Cleaning

Dishwasher resistant.

These new discs can be identified : new appearance and letter W included in the item code.



POTATO RICER

R 502 - R 502 V.V. - R 752 - R 752 V.V.

CL 50 - CL 52 - CL 55 - CL 60

- **High output**

Can produce up to 10 kg of delicious fresh mashed potato in just 2 minutes.

- **Ergonomic**

The extra large ergonomic hopper allows for the continuous processing of potatoes with as little handling as possible.

- **Versatile**

In addition to the 50 existing ways of processing fruit and vegetables, you can also make puree.

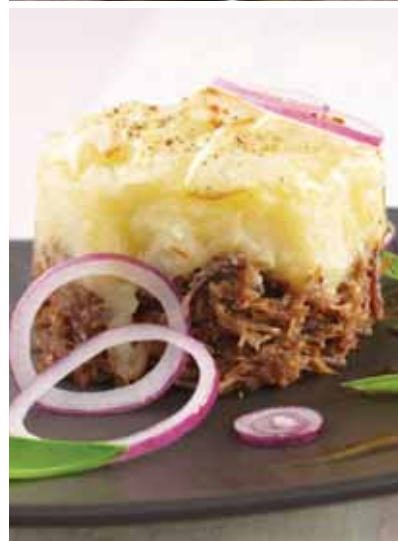

Feed hopper
(for R 502, R 502 V.V.,
CL 50 and CL 50 Ultra only).

Potato Ricer Attachment



Paddle
Puree grid:
3 mm or 6 mm
Special ejection disc

Potato Ricer Equipment



Scan the QR-Code to see the mashed potato function in action.

The Potato Ricer Attachment consists of:

- a feed hopper to handle large quantities of potatoes (for R 502, R 502 V.V., CL 50 and CL 50 Ultra only)
- a paddle
- a special Ø 3 mm or 6 mm grid
- a special puree ejection disc.

		Ref.
Potato Ricer Attachment Ø 3 mm (R 502, R 502 V.V., CL 50 and CL 50 Ultra)	1 + 2	28207
Potato Ricer Equipment Ø 3 mm (R 752, R 752 V.V., CL 52, CL 55 and CL 60)	2	28208
Potato Ricer Attachment Ø 6 mm (R 502, R 502 V.V., CL 50 and CL 50 Ultra)	1 + 2	28209
Potato Ricer Equipment Ø 6 mm (R 752, R 752 V.V., CL 52, CL 55 and CL 60)	2	28210



















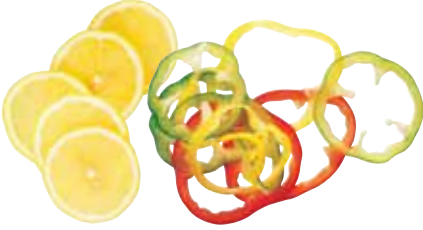







THE WIDEST RANGE OF CUTS

SLICERS

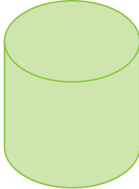

Expert: CL 50, CL 50 Ultra, CL 50 Gourmet, CL 52, CL 55, CL 60, R 502, R 502 V.V., R 752 or R 752 V.V.

Essential: CL 40, R 201, R 201 XL Ultra, R 211 XL Ultra, R 301, R 301 Ultra, R 401, R 402, R 402 V.V.

 <p>Almonds 0.6 mm Ref. 28166W</p> 	 <p>0.8 mm Ref. 28069W</p> 	 <p>1 mm Ref. 28062W Ref. 27051</p> 	
 <p>2 mm Ref. 28063W Ref. 27555</p> 	 <p>3 mm Ref. 28064W Ref. 27086</p> 	 <p>4 mm Ref. 28004W Ref. 27566</p> 	
 <p>5 mm Ref. 28065W Ref. 27087</p> 	 <p>6 mm Ref. 28196W Ref. 27786</p> 	 <p>8 mm Ref. 28066W</p> 	 <p>10 mm Ref. 28067W</p> 
 <p>14 mm* Ref. 28068W</p> 	 <p>Cooked potatoes 4 mm Ref. 27244W</p> 	 <p>Cooked potatoes 6 mm Ref. 27245W</p> 	

The green discs show the actual size

*Except CL 50 Gourmet



GRATERS



Expert: CL 50, CL 50 Ultra, CL 50 Gourmet, CL 52, CL 55, CL 60, R 502, R 502 V.V., R 752 or R 752 V.V.
 Essential: CL 40, R 201, R 201 XL Ultra, R 211 XL Ultra, R 301, R 301 Ultra, R 401, R 402, R 402 V.V.
 Essential: Special CL 40

1.5 mm
 Ref. 28056W
 Ref. 27588*
 Ref. 27148



2 mm
 Ref. 28057W
 Ref. 27577*
 Ref. 27149

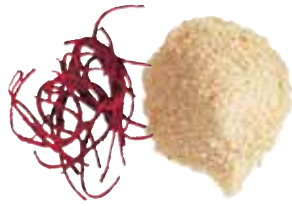

3 mm
 Ref. 28058W
 Ref. 27511*
 Ref. 27150



4 mm
 Ref. 28073W



5 mm
 Ref. 28059W



6 mm
 Ref. 27046



7 mm
 Ref. 28016W



9 mm
 Ref. 28060W
 Ref. 27632



Parmesan cheese
 Ref. 28061W
 Ref. 27764



Röstis potatoes
 Ref. 27164W
 Ref. 27191



Raw potatoes
 Ref. 27219W



Horseradish
 Ref. 28055W 1 mm
 Ref. 27078 0.7 mm
 Ref. 27079 1 mm
 Ref. 27130 1.3 mm



RIPPLE CUT



Expert: CL 50, CL 50 Ultra, CL 50 Gourmet, CL 52, CL 55, CL 60, R 502, R 502 V.V., R 752 or R 752 V.V.
 Essential: CL 40, R 201, R 201 XL Ultra, R 211 XL Ultra, R 301, R 301 Ultra, R 401, R 402, R 402 V.V.

2 mm
 Ref. 27068W
 Ref. 27621



3 mm
 Ref. 27069W



5 mm
 Ref. 27070W



The green discs show the actual size

*Except CL 40

THE WIDEST RANGE OF CUTS

JULIENNE

Expert: CL 50, CL 50 Ultra, CL 50 Gourmet, CL 52, CL 55, CL 60, R 502, R 502 V.V., R 752 or R 752 V.V.

Essential: CL 40, R 201, R 201 XL Ultra, R 211 XL Ultra, R 301, R 301 Ultra, R 401, R 402, R 402 V.V.









 <p>1 x 8 mm ribbons Ref. 28172W</p> 	 <p>1 x 26 mm onions & cabbage Ref. 28153W</p> 	 <p>2 x 4 mm Ref. 27072W Ref. 27080</p> 	 <p>2 x 6 mm Ref. 27066W Ref. 27081</p> 
 <p>2 x 8 mm Ref. 27067W</p> 	 <p>2 x 10 mm Tagliatelles Ref. 28173W</p> 	 <p>2 x 2 mm Ref. 28051W Ref. 27599</p> 	 <p>2.5 x 2.5 mm Ref. 28195W</p> 
 <p>3 x 3 mm Ref. 28101W</p> 	 <p>4 x 4 mm Ref. 28052W Ref. 27047</p> 	 <p>6 x 6 mm Ref. 28053W Ref. 27610</p> 	 <p>8 x 8 mm Ref. 28054W Ref. 27048</p> 

FRENCH FRIES

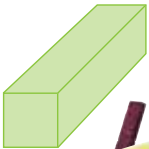
Expert: CL 50, CL 50 Ultra, CL 50 Gourmet, CL 52, CL 55, CL 60, R 502, R 502 V.V., R 752 or R 752 V.V.

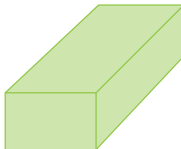
Essential: CL 40, R 402, R 402 V.V.

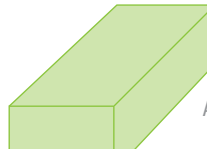
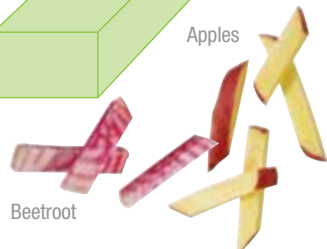

 <p>8 x 8 mm Ref. 28134W Ref. 27116</p>  <p>Purple potatoes</p>	 <p>8 x 16 mm Ref. 28159W</p>  <p>Sweet potatoes</p>	 <p>10 x 10 mm Ref. 28135W Ref. 27117</p>  <p>Apples</p>	 <p>10 x 16 mm Ref. 28158W</p>  <p>Apples Beetroot</p>
--	---	---	---

The green discs show the actual size



DICING EQUIPMENT

Expert: CL 50, CL 50 Ultra, CL 50 Gourmet, CL 52, CL 55, CL 60, R 502, R 502 V.V., R 752 or R 752 V.V.

Essential: CL 40, R 402, R 402 V.V.

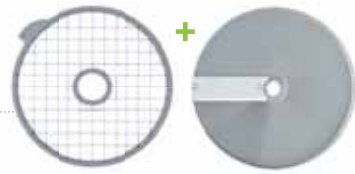

5x5x5 mm
Ref. 28110W



8x8x8 mm
Ref. 28111W
Ref. 27113



10x10x10 mm
Ref. 28112W
Ref. 27114



12x12x12 mm*
Ref. 28197W
Ref. 27298



14x14x5 mm
Ref. 28181W



14x14x10 mm
Ref. 28179W

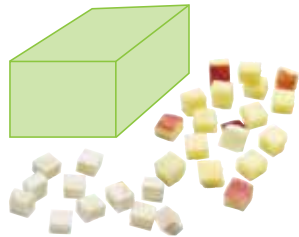

14x14x14 mm*
Ref. 28113W

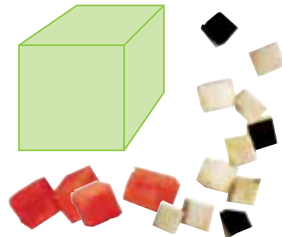

20x20x20 mm*
Ref. 28114W

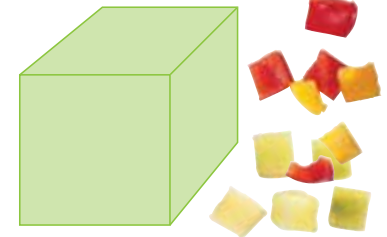

25x25x25 mm*
Ref. 28115W

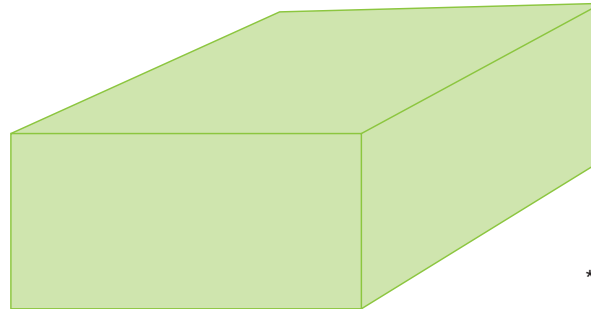
50x70x25 mm*
Salads
Ref. 28180W



*Except CL 50 Gourmet

NEW

EasyClean Xpress

The zero waste solution to clean EXPERT dicing grids R 502 to R 752 and CL 50 to CL 60

- Fast, easy cleaning
- Zero waste

For dicing grids	Ref.
8 mm	49305
10 mm	49309
12 mm	49313
14 mm	49314



NEW

D-CLEAN KIT

Dicing grid cleaning tool



- Grid holder**
- Essential R 402 - CL 40
 - Expert R 502 to R 752 - CL 50 to CL 60

+



Dicing grid cleaning tool
5 mm, 8 mm, 10 mm, 12 mm and 14 mm

+



Scraper tool

	Ref.
D-Clean Kit	29246

BACK TO SUMMARY



EXCLUSIVE CUTS

BRUNOISE

CL 50 Gourmet



CL 50 GOURMET

 **2x2x2 mm**
Ref. 28174W



 **3x3x3 mm**
Ref. 28175W



 **4x4x4 mm**
Ref. 28176W



WAFFLE CUTS

CL 50 Gourmet

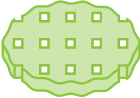

CL 50 GOURMET

 **2 mm**
Ref. 28198W



 **3 mm**
Ref. 28199W



 **4 mm**
Ref. 28177W



 **6 mm**
Ref. 28178W



The green discs show the actual size



PREPARED ON SITE WITH ROBOT-COUCPE

Prepare your own potato dishes and add that all important "Homemade" claim.



Robot-Coupe offers many solutions for preparing homemade potato dishes with and without the skin:

Potato chips of every shape and size!



8 x 8 mm



8 x 16 mm



10 x 10 mm



10 x 16 mm

Shoestring fries



2 x 2 mm

Potato straws



4 x 4 mm



6 x 6 mm

Waffle-cut chips



2 x 2 mm

Pan-fried potatoes



14 x 14 mm or 20 x 20 mm

Potato crisps



1 or 2 mm

Scalloped Potatoes



5 mm

Mashed potatoes



VEGETABLE PREPARATION MACHINES

TABLE-TOP VEGETABLE PREPARATION MACHINES

p.54

FLOOR STANDING VEGETABLE PREPARATION MACHINES

p.64



THE WIDEST RANGE OF CUTS

Thanks to our range of Vegetable Preparation Machines, you can save hours of preparation in the kitchen: slicing, grating, chopping, shredding, julienne, brunoises, chip cutting, waffle cuts and even purees.



TABLE-TOP

VEGETABLE PREPARATION MACHINES

Large hopper

to insert large vegetables such as cabbage and eggplant... and optimised loading of other vegetables.



Hinge and stem system

designed for instant removal of the lid for easy cleaning.

Easy Guide

Stainless steel motor body

Cylindrical hopper

- Ø 58 mm uniform cutting of long ingredients.
- Ø 39 mm to cut up small fruit and vegetables such as chillis, gherkins, dry sausage, asparagus, spring onions, bananas, strawberries, grapes, etc. with the Exactitube pusher.

Lateral ejection

Space saving and convenient to use.



Scan the QR Code to see the vegetable preparation machine in action.

More than 50 optional discs for slicing, ripple cutting, grating, chopping, chip cutting and julienne.

INNOVATION

EXACTITUBE PUSHER

The secret of exclusive cuts!
For slicing small and delicate ingredients such as chillis, gherkins, dry sausage, asparagus, spring onions, bananas, strawberries and grapes.



THE WIDEST RANGE OF CUTS

Robot-Coupe vegetable preparation machines have more than 50 discs to process not only fruit and vegetables but also cheese and sausage.



POTATO RICER CL 50, CL 52, CL 55, CL 60



Scan the QR-Code to see the mashed potato function in action.



Potato Ricer Attachment



Feed hopper
(for CL 50 and CL 50 Ultra only).



Paddle
Puree grid:
3 mm or 6 mm

Special ejection disc

Potato Ricer Equipment

The Potato Ricer Attachment consists of:

- a feed hopper to handle large quantities of potatoes (for CL 50 and CL 50 Ultra only)
- a paddle
- a special Ø 3 mm or 6 mm grid
- a special puree ejection disc.



		Ref.
Potato Ricer Attachment Ø 3 mm (CL 50 and CL 50 Ultra)	1 + 2	28207
Potato Ricer Equipment Ø 3 mm	2	28208
Potato Ricer Attachment Ø 6 mm (CL 50 and CL 50 Ultra)	1 + 2	28209
Potato Ricer Equipment Ø 6 mm	2	28210

TABLE-TOP VEGETABLE PREPARATION MACHINES



Effective throughput per hour:



Up to 50 kg



Up to 50 kg



Up to 150 kg

GRATING / SLICING / RIPPLE CUT / JULIENNE

+ DICING + FRENCH FRIES

+ BRUNOISE & WAFFLE-CUT

+ PARSLEY & HERBS

CL 50 Gourmet



- Single or Three phase
- 1 speed

CL 50 Ultra



- Single or Three phase
- 1 speed
- **Potato Ricer Attachment***

CL 50



- Single or Three phase
- 1 speed
- **Potato Ricer Attachment***

CL 20



- Single phase
- 1 speed

CL 40



- Single phase
- 1 speed

Find all our floor standing models on page 66

*Optional attachments



Up to 150 kg



Up to 250 kg

GRATING / SLICING / RIPPLE CUT / JULIENNE

+ DICING + FRENCH FRIES

CL 50 Ultra Pizza



CL 50 Ultra Restaurants



Restaurants pack available for models CL 50, CL 52 (excluding Gourmet).

CL 50 Ultra Institutions



Institutions pack available for models CL 50, CL52 (excluding Gourmet).

CL 52



- Single or Three phase
- 1 speed
- Potato Ricer Equipment*

TABLE-TOP VEGETABLE PREPARATION MACHINES



Area 104 cm²

“Discover all the disc packs on page 41”

CL 20

Induction motor	✓
Power	400 W
Voltage	Single phase
Speed	1 500 rpm
Feed hoppers	Half moon hopper Cylindrical hopper Ø 58 mm
Lid and bowl	Composite material
Motor base	Composite material
D-Clean Kit	-
Discs	Not included

Choose your model:

CL 20	Ref.
CL 20 230V/50/1	22394
CL 20 230V/50/1 UK plug	22395
CL 20 230V/50/1 DK	22397
CL 20 220V/60/1	22398
CL 20 120V/60/1	22399



Area 104 cm²

“Discover all the disc packs on page 41”

CL 40

Induction motor	✓
Power	500 W
Voltage	Single phase
Speed	500 rpm
Feed hoppers	Half moon hopper Cylindrical hopper Ø 58 mm
Lid and bowl	Composite lid and stainless steel bowl
Motor base	Metal
D-Clean Kit	Included
Discs	Not included

CL 40	Ref.
CL 40 230V/50/1	24570
CL 40 230V/50/1 UK plug	24571
CL 40 230V/50/1 DK	24577
CL 40 220V/60/1	24574
CL 40 120V/60/1	24575

Choose your pack of discs:

	Ref.
Pack of 5 discs for CL 20	
Slicers 2 mm - 4 mm	
Grater 2 mm	
Julienne 4x4 mm - 8x8 mm	1946
Asia Pack of 4 discs for CL 20	
Slicers 2 mm - 4 mm	
Grater 2 mm	
Julienne 2x2 mm	1904
Eastern Europe Pack of 3 discs for CL 20	
Slicers 2 mm	
Grater 2 mm	
Julienne 4x4 mm	2006
Pack of 6 discs for CL 40	
Slicers 2 mm - 4 mm	
Grater 2 mm	
Julienne 2x2 mm	
Dicing Equipment 10x10x10 mm	1945
Asia Pack of 8 discs for CL 40	
Slicers 2 mm - 4 mm	
Grater 2 mm	
Julienne 2x2 mm - 2x4 mm - 4x4 mm	
Dicing Equipment 10x10x10 mm	1909

Complete disc collection page 38





CL 50

Induction motor	✓
Power	550 W
Voltage	Single phase or Three phase
Speed	375 rpm
Feed hoppers	Half moon hopper 2.2 L Cylindrical hopper Ø 58 mm and Ø 39 mm, Exactitube pusher - Included
Lid and bowl	Metal
Motor base	Composite material
D-Clean Kit	Included
Discs	Not included

Choose your model:



Scan this QR-Code to see the vegetable slicer in action.

CL 50 - Single phase	Ref.
CL 50 230V/50/1	24440
CL 50 230V/50/1 UK plug	24442
CL 50 230V/50/1 DK	24439
CL 50 220V/60/1	24445
CL 50 120V/60/1	24444
CL 50 - Three phase	Ref.
CL 50 400V/50/3	24446
CL 50 380V/60/3	24448
CL 50 220V/60/3	24447



CL 50 Ultra

Induction motor	✓
Power	550 W
Voltage	Single phase or Three phase
Speed	375 rpm
Feed hoppers	Half moon hopper 2.2 L Cylindrical hopper Ø 58 mm and Ø 39 mm, Exactitube pusher - Included
Lid and bowl	Metal
Motor base	Stainless steel
D-Clean Kit	Included
Discs	Not included

CL 50 Ultra - Single phase	Ref.
CL 50 Ultra 230V/50/1	24465
CL 50 Ultra 230V/50/1 UK plug	24470
CL 50 Ultra 230V/50/1 DK	24466
CL 50 Ultra 220V/60/1	24471
CL 50 Ultra 120V/60/1	24472
CL 50 Ultra - Three phase	Ref.
CL 50 Ultra 400V/50/3	24473
CL 50 Ultra 380V/60/3	24475
CL 50 Ultra 220V/60/3	24474

Choose your pack of discs:

	Ref.
Pack of 8 discs for Restaurants	
Slicers 2 mm - 5 mm Grater 2 mm Julienne 3x3 mm Dicing Equipment 10x10x10 mm French Fries Equipment 10x10x10 mm Wall disc holder	1933W
Pack of 12 discs for Institutions	
Slicers 2 mm - 5 mm Grater 2 mm - 5 mm Julienne 3x3 mm - 4x4 mm Dicing Equipment 10x10x10 mm - 20x20x20 mm French Fries Equipment 10x10x10 mm Wall disc holder x2	1942W
Asia Pack of 7 discs	
Slicers 2 mm - 5 mm Grater 2 mm Julienne 2x2 mm - 3x3 mm Dicing Equipment 10x10x10 mm Wall disc holder	2023W
Eastern Europe Pack of 5 discs	
Slicers 2 mm Grater 2 mm Julienne 4x4 mm Dicing Equipment 10x10x10 mm	2005W

Complete disc collection page 38



Choose your options:

Options	Ref.
Additional Exactitube pusher	49212
Potato Ricer Attachment 3 mm	28207
Potato Ricer Attachment 6 mm	28209
Mini bowl	39716

NEW

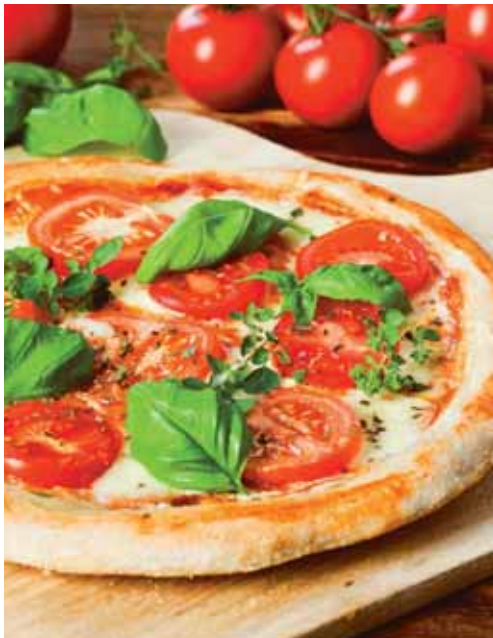

CL 50 Ultra *Pizza*

Our perfect pizza package!

1 slicing disc 4 mm
tomatoes, eggplant, etc.

1 slicing disc 2 mm
zucchini, mushrooms,
capsicum, onions, etc.



1 grating disc 7 mm
mozzarella or pizza
cheese



Area 139 cm²



CL 50 Ultra Pizza

Induction motor	✓
Power	550 W
Voltage	Single phase or Three phase
Speed	375 rpm
Feed hoppers	Half moon hopper 2.2 L Cylindrical hopper Ø 58 mm and Ø 39 mm, Exactitube pusher - Included
Lid and bowl	Metal
Motor base	Stainless steel
D-Clean Kit	Included
Discs	2 mm slicer, 4 mm slicer + 7 mm grater - Included Wall disc holder

Choose your model:

CL 50 Ultra Pizza - Single phase	Ref.
CL 50 Ultra Pizza 230V/50/1 + 3 discs	2027
CL 50 Ultra Pizza 230V/50/1 UK + 3 discs	2028
CL 50 Ultra Pizza 220V/60/1 + 3 discs	2031
CL 50 Ultra Pizza 120V/60/1 + 3 discs	2030
CL 50 Ultra Pizza - Three phase	Ref.
CL 50 Ultra Pizza 400V/50/3 + 3 discs	2033

Complete disc collection page 38



CL 50 GOURMET

Choosing excellence



*58 mm with insert
*68 mm with insert

"Discover all the disk packs on page 42"



CL 50 Gourmet

Induction motor	✓
Power	550 W or 600 W
Voltage	Single phase or Three phase
Speed	375 rpm
Feed hoppers	Half moon hopper 1.6 L Cylindrical hopper Ø 58 mm and Ø 68 mm
Lid and bowl	Metal
Motor base	Stainless steel
D-Clean Kit	Included
Discs	Not included
Collection tray	0,6 L internal collection tray - Included

CL 50 Gourmet - Single phase	Ref.
CL 50 Gourmet 230V/50/1	24453 + 28194
CL 50 Gourmet 230V/50/1 UK plug	24555 + 28194
CL 50 Gourmet 230V/50/1 DK	24452 + 28194
CL 50 Gourmet 220V/60/1	24457 + 28194
CL 50 Gourmet 120V/60/1	24458 + 28194
CL 50 Gourmet - Three phase	Ref.
CL 50 Gourmet 400V/50/3	24459 + 28194

Complete disc collection page 38



BACK TO SUMMARY

3 brunoise discs

2 mm - 3 mm - 4 mm



Brunoise

Options	Ref.
Brunoise 2 x 2 x 2 mm	28174W
Brunoise 3 x 3 x 3 mm	28175W
Brunoise 4 x 4 x 4 mm	28176W

4 waffle cut discs

2 mm - 3 mm - 4 mm - 6 mm

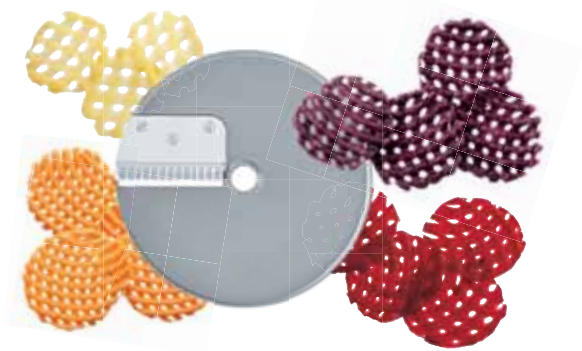

Waffle cut

Options	Ref.
Waffle cut 2 mm	28198W
Waffle cut 3 mm	28199W
Waffle cut 4 mm	28177W
Waffle cut 6 mm	28178W

PARSLEY AND HERB KIT

2 inserts



1 mm parsley including:

one 1-mm slicer and two inserts for guiding parsley while it is being chopped

Ref.

1 mm parsley kit	28194
------------------	-------

CL 52

Designed to cut up large amounts of vegetables in no time at all.



- Requires less effort
- Prevents MSD
- Takes away the painfulness of work



HIGH PRECISION

Cylindrical hopper

- Ø 58 mm uniform cutting of long ingredients.
- Ø 39 mm to cut up small fruit and vegetables such as chillis, gherkins, dry sausage, asparagus, spring onions, bananas, strawberries, grapes, etc. with the Exactitube pusher.

EXTRA LARGE

The very wide opening of the hopper is designed to take up to 15 tomatoes at a time.



Easy Guide

EXTRA POWERFUL

Stainless steel motor base for easy maintenance.
750 W ultra-powerful silent commercial grade motor.



INNOVATION



EXTRA ERGONOMIC

Lever with assisted movement = less effort for the operator + increase throughput.



Scan this QR-Code to see the vegetable preparation machine in action.

LATERAL EJECTION

Space saving and less strain.

Special cabbage tool for better ejection.





Area 227 cm²

“Discover all the disk packs on page 42”



CL 52

Induction motor	✓
Power	750 W
Voltage	Single phase or Three phase
Speed	375 rpm
Feed hoppers	Full moon hopper 4.4 L Cylindrical hopper Ø 58 mm and Ø 39 mm, Exactitube pusher - Included
Lid and bowl	Metal
Motor base	Stainless steel
Accessories	Motor shaft brush - Included, coming soon
D-Clean Kit	Included
Discs	Not included

Choose your model:



Scan this QR-Code to see the vegetable slicer in action.

CL 52 - Single phase	Ref.
CL 52 230V/50/1	24490
CL 52 230V/50/1 UK plug	24492
CL 52 230V/50/1 DK	24489
CL 52 220V/60/1	24494
CL 52 120V/60/1	24496
CL 52 - Three phase	Ref.
CL 52 400V/50/3	24498
CL 52 380V/60/3	24500
CL 52 220V/60/3	24499



Choose your pack of discs:

							Ref.
Pack of 8 discs for Restaurants							
Slicers 2mm - 5mm	Grater 2mm	Julienne 3x3mm	Dicing Equipment 10x10x10mm	French Fries Equipment 10x10x10mm	Wall disc holder		1933W
Pack of 12 discs for Institutions							
Slicers 2mm - 5mm	Grater 2mm - 5mm	Julienne 3x3mm - 4x4mm	Dicing Equipment 10x10x10mm - 20x20x20mm	French Fries Equipment 10x10x10mm	Wall disc holder x2		1942W
Asia Pack of 7 discs							
Slicers 2mm - 5mm	Grater 2mm	Julienne 2x2mm - 3x3mm	Dicing Equipment 10x10x10mm		Wall disc holder		2023W
Eastern Europe Pack of 5 discs							
Slicers 2mm	Grater 2mm	Julienne 4x4mm	Dicing Equipment 10x10x10mm				2005W

Complete disc collection page 38



Choose your options:

		CL 52
Options		Ref.
Additional Exactitube pusher		49221
Potato Ricer Equipment 3 mm		28208
Potato Ricer Equipment 6 mm		28210
Motor shaft brush - Coming soon		49257

FLOOR STANDING VEGETABLE PREPARATION MACHINES

Especially designed for the preparation of large quantities of vegetables.

HIGH PRECISION

Cylindrical hopper

- Ø 58 mm uniform cutting of long ingredients.
- Ø 39 mm to cut up small fruit and vegetables such as chillis, gherkins, dry sausage, asparagus, spring onions, bananas, strawberries, grapes, etc. with the Exactitube pusher.

EXTRA LARGE

The very wide opening of the hopper is designed to take up to 15 tomatoes at a time.

POWERFUL MOTOR

1500 W silent induction motor for durability.
Stainless steel motor base for easy cleaning.

INNOVATION

EXTRA ERGONOMIC

Lever with assisted movement = less effort for the operator + increase throughput.



- Requires less effort
- Prevents MSD
- Takes away the tediousness

LATERAL EJECTION

Space-saving and user comfort.



CL 55 automatic feed-head



CL 55 pusher feed-head
(Surface area 227 sq.cm.)
with built-in tube



CL 55 4-tube feed head
2 Ø 50 mm tubes / 2 Ø 70 mm tubes



CL 55 2-tube feed head
Straight and slanted tubes

FLOOR STANDING VEGETABLE PREPARATION MACHINES



Practical throughput
per hour:



400 kg

GRATING / SLICING / RIPPLE CUT / JULIENNE

+ DICING + FRENCH FRIES

CL 55 Pusher Feed-Head

OPTIONAL
+
50
DISCS



- Three phase or single phase
- 1 or 2 speeds
- Potato Ricer Equipment*

CL 55 2 Feed-Heads

OPTIONAL
+
50
DISCS



- Three phase or single phase
- 1 or 2 speeds
- Potato Ricer Equipment*

CL 55 Workstation

OPTIONAL
+
50
DISCS



- Three phase or single phase
- 1 or 2 speeds
- Potato Ricer Equipment

Find all our table-top models on page 56

*Optional attachments



GRATING / SLICING / RIPPLE CUT / JULIENNE

+ DICING + FRENCH FRIES

CL 60 Pusher Feed-Head



OPTIONAL
+
50
DISCS

- Three phase or single phase
- 2 speeds or variable speed
- Potato Ricer Equipment*

CL 60 2 Feed-Heads



OPTIONAL
+
50
DISCS

- Three phase or single phase
- 2 speeds or variable speed
- Potato Ricer Equipment*

CL 60 Workstation

OPTIONAL
+
50
DISCS



- Three phase or single phase
- 2 speeds or variable speed
- Potato Ricer Equipment



FLOOR STANDING VEGETABLE PREPARATION MACHINES



Area 227 cm²

"Discover all the disk packs on page 42"



Area 227 cm²

"Discover all the disk packs on page 42"

CL 55 Pusher Feed-Head

CL 55 2 Feed-Heads

Induction motor	✓	
Power	750 W	1 100 W
Voltage	Single phase	Three phase
Speed	375 rpm	375 rpm - 750 rpm
Feed-Heads	Full moon pusher feed head 4.4 L Cylindrical hoppers Ø 58 mm and Ø 39 mm, Exactitube pusher - Included	
Lid and bowl	Metal	
Motor base	Stainless steel	
Mobile stand	Stainless steel Equipped with 2 wheels and brake	
Accessories	Motor shaft brush - Included, coming soon	
D-Clean Kit	Included	
Discs	Not included	

Choose your model:

CL 55 Pusher Feed-Head - Three phase	Ref.
CL 55 Pusher Feed-Head 400V/50/3	2214
CL 55 Pusher Feed-Head 380V/60/3	2229
CL 55 Pusher Feed-Head 220V/60/3	2234
CL 55 Pusher Feed-Head - Single phase	Ref.
CL 55 Pusher Feed-Head 230V/50/1	2245
CL 55 Pusher Feed-Head 230V/50/1 UK plug	2252
CL 55 Pusher Feed-Head 220V/60/1	2264
CL 55 Pusher Feed-Head 120V/60/1	2276

Induction motor	✓	
Power	750 W	1 100 W
Voltage	Single phase	Three phase
Speed	375 rpm	375 rpm - 750 rpm
Feed-Heads	Stainless steel automatic feed tube Full moon pusher feed head 4.4 L Cylindrical hoppers Ø 58 mm and Ø 39 mm, Exactitube pusher - Included	
Lid and bowl	Metal	
Motor base	Stainless steel	
Mobile stand	Stainless steel Equipped with 2 wheels and brake	
Accessories	Motor shaft brush - Included, coming soon	
D-Clean Kit	Included	
Discs	Not included	

CL 55 2 Feed-Heads - Three phase	Ref.
CL 55 2 Feed-Heads 400V/50/3	2211
CL 55 2 Feed-Heads 380V/60/3	2227
CL 55 2 Feed-Heads 220V/60/3	2233
CL 55 2 Feed-Heads - Single phase	Ref.
CL 55 2 Feed-Heads 230V/50/1	2244
CL 55 2 Feed-Heads 220V/60/1	2263
CL 55 2 Feed-Heads 120V/60/1	2275

Choose your pack of discs:

						Ref.
Pack of 8 discs for Restaurants						
Slicers 2mm - 5mm	Grater 2mm	Julienne 3x3mm	Dicing Equipment 10x10x10mm	French Fries Equipment 10x10x10mm	Wall disc holder	1933W
Pack of 12 discs for Institutions						
Slicers 2mm - 5mm	Grater 2mm - 5mm	Julienne 3x3mm - 4x4mm	Dicing Equipment 10x10x10mm - 20x20x20mm	French Fries Equipment 10x10x10mm	Wall disc holder x2	1942W
Asia Pack of 7 discs						
Slicers 2mm - 5mm	Grater 2mm	Julienne 2x2mm - 3x3mm	Dicing Equipment 10x10x10mm	Wall disc holder		2023W
Eastern Europe Pack of 5 discs						
Slicers 2mm	Grater 2mm	Julienne 4x4mm	Dicing Equipment 10x10x10mm			2005W

Complete disc collection page 38



CL 55 ACCESSORIES



Automatic feed-head
Ref. 28170



Pusher feed-head
with built-in tube
(surface area 227 sq.cm.)
Ref. 39673



4-tubes feed-head
2 Ø 50 mm tubes
2 Ø 70 mm tubes
Ref. 28161



Straight and bias tubes
Ref. 28155



Potato Ricer Equipment
Ref. 28208 Ø 3 mm
Ref. 28210 Ø 6 mm



NEW

Exactitube pusher
CL 52 - CL 55 - CL 60
Ref. 49221

Coming soon



Motor shaft brush
Ref. 49257



3-height adjustable trolley GN1x1
Delivered without container
Ref. 49128



Storage trolley for 16 discs,
8 attachments and 3 feed heads,
delivered with 1 GN1x1 container
(attachments not included)
Ref. 49132



CL 55 Workstation

Up to
1.200 kg of
vegetables
an hour

175 mm
59 mm

Area 227 cm²

3-height ADJUSTABLE TROLLEY
For easy transport and loading
of fruit and vegetables and storing
of attachments.



CL 55 Workstation

Induction motor	✓	
Power	750 W	1 100 W
Voltage	Single phase	Three phase
Speed	375 rpm	375 rpm - 750 rpm
Feed hoppers	Stainless steel automatic feed tube Full moon pusher feed head 4.4 L Cylindrical hoppers Ø 58 mm and Ø 39 mm, Exactitube pusher - Included	
Lid and bowl	Metal	
Motor base	Stainless steel	
Accessories	Stainless steel mobile stand - Equipped with 2 wheels with brake - Included Adjustable trolley GN1x1, 3 heights + 3 GN1x1 containers - Included 3 mm Potato Ricer Equipment - Included Motor shaft brush - Included, coming soon	
D-Clean Kit	Included	
Discs	MultiCut Pack of 16 discs - Included	

CL 55 Workstation - Three Phase		Ref.
CL 55 Workstation 400V/50/3		2287
CL 55 Workstation 380V/60/3		2289
CL 55 Workstation 220V/60/3		2288
CL 55 Workstation - Single Phase		Ref.
CL 55 Workstation 230V/50/1		2290
CL 55 Workstation 230V/50/1 UK		2293
CL 55 Workstation 220V/60/1		2292
CL 55 Workstation 120V/60/1		2291

FLOOR STANDING VEGETABLE PREPARATION MACHINES



Area 227 cm²

"Discover all the disk packs on page 42"



Area 227 cm²

"Discover all the disk packs on page 42"



CL 60 Pusher Feed-Head CL 60 V.V. Pusher Feed-Head

CL 60 2 Feed-Heads CL 60 V.V. 2 Feed-Heads

Induction motor	✓	
Power	1 500 W	
Voltage	Three phase	Single phase
Speed	375 rpm - 750 rpm	100 to 1 000 rpm
Feed-Heads	Full moon pusher feed-head 4.9 L Cylindrical hopper Ø 58 mm and Ø 39 mm, Exactitube pusher - Included	
Bowl	Stainless steel	
Motor base	Stainless steel	
Equipped with	1 adjustable foot for all floor types 2 wheels 1 stainless steel container for cutting attachments	
Accessories	Motor shaft brush - Included, coming soon	
D-Clean Kit	Included	
Discs	Not included	

Induction motor	✓	
Power	1 500 W	
Voltage	Three phase	Single phase
Speed	375 rpm - 750 rpm	100 to 1 000 rpm
Feed-Heads	Stainless steel automatic feed tube Full moon pusher feed-head 4.9 L Cylindrical hopper Ø 58 mm and Ø 39 mm, Exactitube pusher - Included	
Bowl	Stainless steel	
Motor base	Stainless steel	
Equipped with	1 adjustable foot for all floor types 2 wheels 1 stainless steel container for cutting attachments	
Accessories	Motor shaft brush - Included, coming soon	
D-Clean Kit	Included	
Discs	Not included	

Choose your model:



Scan this QR-Code to see the vegetable preparation machine in action.

Choose your pack of discs:

CL 60 Pusher Feed-Head - Three Phase	Ref.
CL 60 Pusher Feed-Head 400V/50/3	2319
CL 60 Pusher Feed-Head 380V/60/3	2320
CL 60 Pusher Feed-Head 220V/60/3	2321
CL 60 V.V. Pusher Feed-Head - Single Phase	Ref.
CL 60 V.V. Pusher Feed-Head 230V/50-60/1	2323

CL 60 2 Feed-Heads - Three Phase	Ref.
CL 60 2 Feed-Heads 400V/50/3	2325
CL 60 2 Feed-Heads 380V/60/3	2326
CL 60 2 Feed-Heads 220V/60/3	2327
CL 60 V.V. 2 Feed-Heads - Single Phase	Ref.
CL 60 V.V. 2 Feed-Heads 230V/50-60/1	2329

						Ref.
Pack of 8 discs for Restaurants						
Slicers 2 mm - 5 mm	Grater 2 mm	Julienne 3x3 mm	Dicing Equipment 10x10x10 mm	French Fries Equipment 10x10x10 mm	Wall disc holder	1933W
Pack of 12 discs for Institutions						
Slicers 2 mm - 5 mm	Grater 2 mm - 5 mm	Julienne 3x3 mm - 4x4 mm	Dicing Equipment 10x10x10 mm - 20x20x20 mm	French Fries Equipment 10x10x10 mm	Wall disc holder x2	1942W
Asia Pack of 7 discs						
Slicers 2 mm - 5 mm	Grater 2 mm	Julienne 2x2 mm - 3x3 mm	Dicing Equipment 10x10x10 mm	Wall disc holder		2023W
Eastern Europe Pack of 5 discs						
Slicers 2 mm	Grater 2 mm	Julienne 4x4 mm	Dicing Equipment 10x10x10 mm			2005W

Complete disc collection page 38



CL 60 ACCESSORIES



Automatic feed-head
With feeding tray
Ref. 39681



Pusher feed-head
Ref. 39680



4 tubes feed-head
2 Ø 50 mm tubes
2 Ø 70 mm tubes
Ref. 28162



Straight and bias tubes
Ref. 28157



Potato Ricer Equipment
Ref. 28208 Ø 3 mm
Ref. 28210 Ø 6 mm



Exactitube pusher
CL 52 - CL 55 - CL 60
Ref. 49221

Coming soon



Motor shaft brush
Ref. 49257



Ergo mobile trolley
Supplied without container.
Designed to take 3 GN1x1
gastronorm containers.
Ref. 49066



Storage trolley for 16 discs,
8 attachments and 3 feed heads,
delivered with 1 GN1x1 container
(attachments not included)
Ref. 49132



CL 60 Workstation

Up to
1800 kg of
vegetables
an hour

STORAGE TROLLEY



Adjustable leg
so it can be adapted to uneven
floors and ensure stability.

CL 60 Workstation

Induction motor	✓
Power	1 500 W
Voltage	Three phase Single phase
Speed	375 rpm - 750 rpm 100 to 1 000 rpm
Feed-Heads	Stainless steel automatic feed head Full moon pusher feed head 4.9 L Cylindrical hopper Ø 58 mm and Ø 39 mm, Exactitube pusher - Included 4 tubes: 2 Ø 50mm tubes and 2 Ø 70mm tubes
Lid and bowl	Metal
Motor base	Stainless steel
Equipped with	1 adjustable foot for all floor types 2 wheels 1 stainless steel container for cutting attachments.
Accessories	Ergo mobile trolley with 3 GN1x1 gastronorm containers - Included Storage trolley with 1 GN1x1 gastronorm container - Included 3 mm Potato Ricer Equipment - Included Motor shaft brush - Included, coming soon
D-Clean Kit	Included
Discs	MultiCut Pack of 16 discs - Included

CL 60 Workstation - Three Phase	Ref.
CL 60 Workstation 400V/50/3	2300
CL 60 Workstation 380V/60/3	2304
CL 60 Workstation 220V/60/3	2302
CL 60 V.V. Workstation - Single Phase	Ref.
CL 60 V.V. Workstation 230V/50/1	2301



Scan this QR-Code to see
the vegetable preparation
machine in action.

A COMPLETE COLLECTION OF ATTACHMENTS INCLUDED!

Automatic feed-head

For all bulky vegetables (tomatoes, onions, potatoes, etc.).



Pusher feed-head

Especially designed for bulky vegetables such as cabbage and celeriac.



4 tubes feed-head

Especially designed for long vegetables such as cucumbers and zucchini.



Exactitube pusher

For cutting up small sized fruit and vegetables such as chillis, gherkins, dry sausage, asparagus, spring onions, bananas, strawberries and grapes.



3 mm Potato Ricer Equipment

To easily produce large quantities of mashed potatoes.



Storage trolley

To store and transport all the attachments! Tray for 16 discs and 8 attachments. GN1X1 container for kitchen utensils.



Coming soon Motor shaft brush



MultiCut Pack

16 discs included.



Slicers

Graters

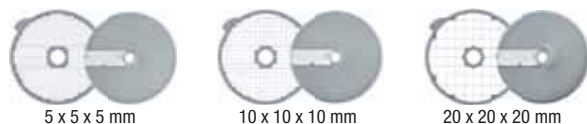

Dicing Equipment



French Fries

Juliennes



4 wall mounted disc holders for 16 discs

Ergo Mobile Trolley

To transport, load and store accessories. 3 GN1x1 gastronorm containers provided.



CUTTERS MIXERS

TABLE TOP CUTTER MIXERS

p.78

FLOOR STANDING VERTICAL CUTTER MIXERS

p.90



THE MUST FOR PASTRY AND KITCHEN CHEFS!

With its bowl-base twin-blade assembly - a Robot-Coupe exclusivity - it is the Chef's ideal assistant. Whether you need small or large quantities, all your preparations can be made by just pressing a button: sauces, minced meat and fish, chopped onions, herbs and spices, ground nuts and chocolate, praline, kneading, etc.



TABLE TOP CUTTER MIXERS

LID

Liquids and other ingredients can be added during processing.

NEW

BOWL

7.5L: to save time by increasing the quantities processed.

ERGONOMIC HANDLE

Soft touch handle designed for more comfort and for a firm and secure grip.



Scan the QR-Code to see the cutter mixers in action.

Easy Guide

robot coupe[®]

000



R 7 V.V.

7,5 L

TIMER

Less effort, greater precision and more regular results no matter what the recipe.



INNOVATION

BOWL-BASE TWIN-BLADE ASSEMBLY

To process both large and small quantities. All stainless steel with detachable smooth blade. Optional coarse and fine serrated blade.

Variable speed models:

300 to 3 500 rpm for more flexible use and a greater variety of applications.

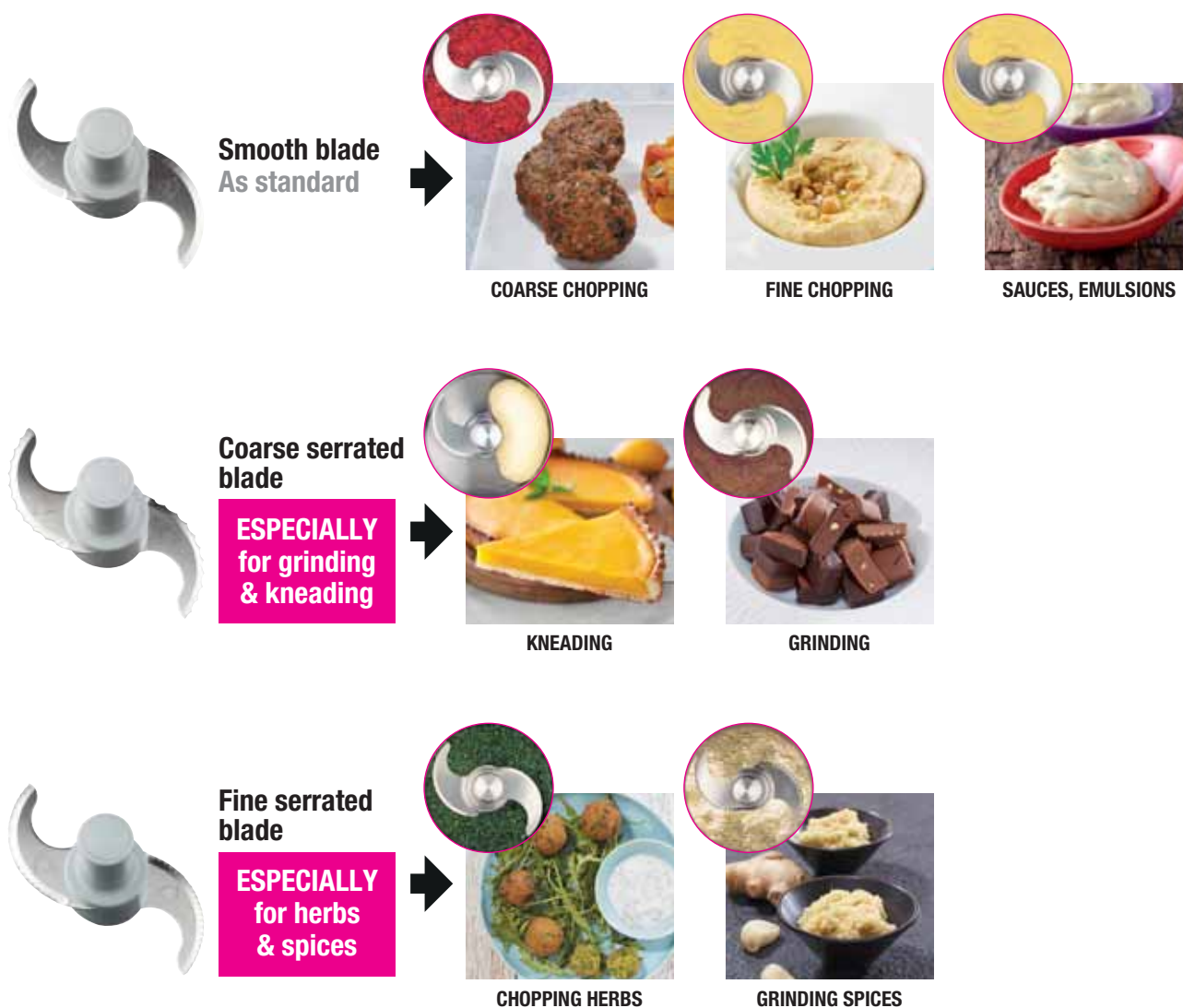

R-MIX FUNCTION **R-Mix®**

On R 5 V.V., R 7 V.V., R 8 V.V., R 10 V.V.

- To blend delicate ingredients without chopping.
- The **R-Mix®** function is designed for reverse rotation blending at **variable speeds from 60 to 500 rpm** to incorporate whole pieces of meat, crayfish tails, brunoises and diced vegetables to pâtés and terrines, whole raisins to buns, etc.



TABLE-TOP CUTTER MIXERS



Quantities*



1 kg



1,5 kg



2,5 kg



3 kg

VARIABLE SPEED from 300 to 3 500 rpm

R 4 V.V.

R 5 V.V.

OPTIONAL
3
BLADES

4.5 L



• Single phase

OPTIONAL
3
BLADES

5.9 L



• Single phase
• R-Mix®

1 SPEED 1 500 rpm

1 SPEED 3 000 rpm

2 SPEEDS 1 500 and 3 000 rpm

R 2

R 3-3000

R 4 - 2V

R 5 - 2V

OPTIONAL
3
BLADES

2.9 L



• Single phase

OPTIONAL
3
BLADES

3.7 L



• Single phase

OPTIONAL
3
BLADES

4.5 L



• Three phase

OPTIONAL
3
BLADES

5.9 L



• Three phase

1 SPEED 1 500 rpm

R 2 B

R 3

R 4 - 1V

R 5 - 1V

OPTIONAL
3
BLADES

2.9 L



• Single phase

OPTIONAL
3
BLADES

3.7 L



• Single phase

OPTIONAL
3
BLADES

4.5 L



• Single phase

OPTIONAL
3
BLADES

5.9 L



• Single phase

*Maximum quantities processed at a time



3,5 kg



5 kg



6 kg

VARIABLE SPEED from 300 to 3 500 rpm

R 7 V.V.



- Single phase
- R-Mix®



7.5 L

R 8 V.V.



- Single phase
- R-Mix®



8 L

R 10 V.V.



- Single phase
- R-Mix®



11.5 L

2 SPEEDS 1 500 and 3 000 rpm

R 7



- Three phase



7.5 L

R 8



- Three phase

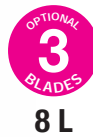

8 L

R 10



- Three phase

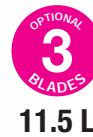

11.5 L

R-Mix®: Reverse rotation blending function

PERFORMANCE RATES

Models	Maximum capacity				Number of covers	Time
	Coarse chopping (up to)	Emulsions (up to)	Pastry/dough* (up to)	Grinding (up to)		
R 2	0,8 kg	1 kg	0,5 kg	0,3 kg	1 to 50	1 to 4 minutes
R 3	1 kg	1,5 kg	1 kg	0,5 kg	1 to 50	
R 3-3000	1 kg	1,5 kg	-	0,5 kg	1 to 50	
R 4 - 1V / R 4 - 2V / R 4 V.V.	1,5 kg	2,5 kg	1,5 kg	0,7 kg	50 to 100	
R 5 - 1V / R 5 - 2V / R 5 V.V.	2,2 kg	3,2 kg	2,2 kg	1,1 kg	50 to 200	
R 7 / R 7 V.V.	2,7 kg	3,8 kg	2,7 kg	1,7 kg	100 to 200	
R 8 / R 8 V.V.	3 kg	5 kg	4 kg	2 kg	200 to 300	
R 10 / R 10 V.V.	4 kg	6 kg	5 kg	3 kg	200 to 300	

*Amount of raised dough with 60% hydration

Find all our floor standing models on page 92

TABLE-TOP CUTTER MIXERS



R 2 B

Induction motor	✓
Power	550 W
Voltage	Single phase
Speed	1 500 rpm
Pulse	✓
Bowl	2.9 L composite material
Blade	Stainless steel smooth blade - Included



R 2

Induction motor	✓
Power	550 W
Voltage	Single phase
Speed	1 500 rpm
Pulse	✓
Bowl	2.9 L stainless steel
Blade	Stainless steel smooth blade - Included

Choose your model:



Scan the QR-Code to see the cutter mixers in action.

R 2 B	Ref.
R 2 B 230V/50/1	22113
R 2 B 220V/60/1	22118
R 2 B 120V/60/1	22116

R 2	Ref.
R 2 230V/50/1	22100
R 2 230V/50/1 UK plug	22107
R 2 230V/50/1 DK	22267
R 2 220V/60/1	22117
R 2 120V/60/1	22109

Choose your options:



R 2 all models	
Options	Ref.
Coarse serrated blade Especially for grinding & kneading	27138
Fine serrated blade Especially for herbs & spices	27061
Additional smooth blade	27055



R 3 - 1500

Induction motor	✓
Power	650 W
Voltage	Single phase
Speed	1 500 rpm
Pulse	✓
Bowl	3.7 L stainless steel
Blade	Stainless steel smooth blade - Included



R 3 - 3000

Induction motor	✓
Power	650 W
Voltage	Single phase
Speed	3 000 rpm
Pulse	✓
Bowl	3.7 L stainless steel
Blade	Stainless steel smooth blade - Included

Choose your model:



Scan the QR-Code to see the cutter mixers in action.

R 3 - 1500	Ref.
R 3-1500 230V/50/1	22382
R 3-1500 230V/50/1 UK plug	22383
R 3-1500 230V/50/1 DK	22385
R 3-1500 220V/60/1	22386
R 3-1500 120V/60/1	22387

R 3 - 3000	Ref.
R 3-3000 230V/50/1	22388
R 3-3000 230V/50/1 UK plug	22389
R 3-3000 230V/50/1 DK	22391
R 3-3000 220V/60/1	22392
R 3-3000 120V/60/1	22393

Choose your options:



R 3 all models	
Options	Ref.
Coarse serrated blade Especially for grinding & kneading	27288
Fine serrated blade Especially for herbs & spices	27287
Additional smooth blade	27286

TABLE-TOP CUTTER MIXERS





R 4 - 1V

Induction motor	✓
Power	700 W
Voltage	Single phase
Speed	1 500 rpm
Pulse	✓
Motor base	Metal
Bowl	4.5 L stainless steel
Blade	Stainless steel smooth blade Included

R 4 - 2V

Induction motor	✓
Power	900 W
Voltage	Three phase
Speed	1 500 rpm - 3 000 rpm
Pulse	✓
Motor base	Metal
Bowl	4.5 L stainless steel
Blade	Stainless steel smooth blade Included

R 4 V.V.

Induction motor	✓
Power	1 000 W
Voltage	Single phase
Speed	300 to 3 500 rpm
Pulse	✓
Motor base	Metal
Bowl	4.5 L stainless steel
Blade	Stainless steel smooth blade Included

Choose your model:



Scan the QR-Code to see the cutter mixers in action.

R 4 - 1V	Ref.
R 4 - 1V 230V/50/1	22430
R 4 - 1V 230V/50/1 UK plug	22434
R 4 - 1V 230V/50/1 DK	22431
R 4 - 1V 220V/60/1	22433
R 4 - 1V 120V/60/1	22432

R 4 - 2V	Ref.
R 4 - 2V 400V/50/3	22437
R 4 - 2V 380V/60/3	22439
R 4 - 2V 230V/50/3	22440
R 4 - 2V 220V/60/3	22438

R 4 V.V.	Ref.
R 4 V.V. 230V/50-60/1	22411
R 4 V.V. 230V/50-60/1 UK plug	22412
R 4 V.V. 230V/50-60/1 DK	22414

Choose your options:



R 4 all models	
Options	Ref.
Coarse serrated blade Especially for grinding & kneading	27346
Fine serrated blade Especially for herbs & spices	27345
Additional smooth blade	27344

TABLE-TOP CUTTER MIXERS



R 5 - 1V

Induction motor	✓
Power	750 W
Voltage	Single phase
Speed	1 500 rpm
Timer	✓
Pulse	✓
Motor base	Metal
Bowl	5.9 L stainless steel
Blade	Stainless steel smooth blade Included Blade cleaning tool - Included, coming soon

R-Mix®

Choose your model:



Scan the QR-Code to see the cutter mixers in action.

R 5 - 1V	Ref.
R 5 - 1V 230V/50/1	24608
R 5 - 1V 230V/50/1 UK plug	24609
R 5 - 1V 220V/60/1	24605

R 5 - 2V

Induction motor	✓
Power	1 500 W
Voltage	Three phase
Speed	1 500 rpm - 3 000 rpm
Timer	✓
Pulse	✓
Motor base	Metal
Bowl	5.9 L stainless steel
Blade	Stainless steel smooth blade Included Blade cleaning tool - Included, coming soon

-

R 5 - 2V	Ref.
R 5 - 2V 400V/50/3	24614
R 5 - 2V 380V/60/3	24613
R 5 - 2V 220V/60/3	24616

R 5 V.V.

Induction motor	✓
Power	1 500 W
Voltage	Single phase
Speed	300 to 3 500 rpm
Timer	✓
Pulse	✓
Motor base	Metal
Bowl	5.9 L stainless steel
Blade	Stainless steel smooth blade Included Blade cleaning tool - Included, coming soon

✓

R 5 V.V.	Ref.
R 5 V.V. 230V/50-60/1	24620
R 5 V.V. 230V/50-60/1 UK plug	24623

Choose your options:



NEW

R 5 all models		
Options	Ref.	
Coarse serrated blade Especially for grinding & kneading	27305	
Fine serrated blade Especially for herbs & spices	27304	
Additional smooth blade	27303	
Scrapers arm	49552	
Blade cleaning tool - Coming soon	49258	



R 7

Induction motor	✓
Power	1 500 W
Voltage	Three phase
Speed	1 500 rpm - 3 000 rpm
Timer	✓
Pulse	✓
Motor base	Metal
Bowl	7.5 L stainless steel
Blade	All stainless steel detachable, adjustable smooth blade assembly - Included
R-Mix®	-



R 7 V.V.

Induction motor	✓
Power	1 500 W
Voltage	Single phase
Speed	300 to 3 500 rpm
Timer	✓
Pulse	✓
Motor base	Metal
Bowl	7.5 L stainless steel
Blade	All stainless steel detachable, adjustable smooth blade assembly - Included
R-Mix®	✓

Choose your model:



Scan the QR-Code to see the cutter mixers in action.

R 7	Ref.
R 7 400/50/3	24658
R 7 220V/60/3	24655

R 7 V.V.	Ref.
R 7 V.V. 230V/50-60/1	24709
R 7 V.V. 230V/50-60/1 UK plug	24711

Choose your options:



R 7 all models	
Options	Ref.
Stainless steel coarse serrated blade Especially for grinding & kneading	27308
Stainless steel fine serrated blade Especially for herbs & spices	27307
Additional stainless steel smooth blade	27306
Lower coarse serrated blade	49162
Upper coarse serrated blade	49163
Lower fine serrated blade	49164
Upper fine serrated blade	49165
Lower smooth blade	49160
Upper smooth blade	49161
NEW Scraper arm	49552

TABLE-TOP CUTTER MIXERS



R 8

Induction motor	✓
Power	2 200 W
Voltage	Three phase
Speed	1 500 rpm - 3 000 rpm
Pulse	✓
Bowl	8 L stainless steel
Blade	All stainless steel detachable, adjustable 2 smooth blade assembly - Included
R-Mix®	-



R 8 V.V.

Induction motor	✓
Power	2 200 W
Voltage	Single phase
Speed	300 to 3 500 rpm
Pulse	✓
Bowl	8 L stainless steel
Blade	All stainless steel detachable, adjustable 2 smooth blade assembly - Included
R-Mix®	✓



Choose your model:



Scan the QR-Code to see the cutter mixers in action.

R 8	Ref.
R 8 400V/50/3	21291
R 8 380V/60/3	21294
R 8 220V/60/3	21293
R 8 230V/50/3	21295

R 8 V.V.	Ref.
R 8 V.V. 220-240V/50-60/1	21285



It is advisable to use a type A or type B GFCI

Choose your options:



R 8 all models	
Options	Ref.
Stainless steel coarse serrated 2-blade assembly Especially for grinding & kneading	27383
Stainless steel fine serrated 2-blade assembly Especially for herbs & spices	27385
Additional stainless steel 2 smooth blade assembly	27381
Coarse serrated blade	59281
Fine serrated blade	59282
Smooth blade	59280
Vacuum adaptation kit R-Vac (without pump)	29996
Vacuum pump 550 W 16 m ² 230V/50/1	69012



Optional additional mini bowl	Ref.
3.5 litre stainless steel bowl R 8 stainless steel smooth blade	27374
Stainless steel coarse serrated blade	27107
Additional stainless steel smooth blade	27106
Coarse serrated blade	101801S
Smooth blade	101800S



R 10

Induction motor	✓
Power	2 600 W
Voltage	Three phase
Speed	1 500 rpm - 3 000 rpm
Pulse	✓
Bowl	11.5 L stainless steel
Blade	All stainless steel detachable, adjustable 3 smooth blade assembly - Included
R-Mix®	-

Choose your model:



Scan the QR-Code to see the cutter mixers in action.

Choose your options:



R 10	Ref.
R 10 400V/50/3	21391
R 10 380V/60/3	21394
R 10 220V/60/3	21393
R 10 230V/50/3	21395



R 10 V.V.

Induction motor	✓
Power	2 600 W
Voltage	Single phase
Speed	300 to 3 500 rpm
Pulse	✓
Bowl	11.5 L stainless steel
Blade	All stainless steel detachable, adjustable 3 smooth blade assembly - Included
R-Mix®	✓

R 10 V.V.	Ref.
R 10 V.V. 220-240V/50-60/1	21385

It is advisable to use a type A or type B GFCI

R 10 all models

Options	Ref.
Stainless steel coarse serrated 3 blade assembly Especially for grinding & kneading	27384
Stainless steel fine serrated 3 blade assembly Especially for herbs & spices	27386
Additional stainless steel 3 smooth blade assembly	27382
Coarse serrated blade	59281
Fine serrated blade	59282
Smooth blade	59280
Vacuum adaptation kit R-Vac (without pump)	29996
Vacuum pump 550 W 16 m ² 230V/50/1	69012



Optional additional mini bowl	Ref.
4 litre stainless steel bowl R 10-R 15 stainless steel smooth blade	27375
Stainless steel coarse serrated blade	27107
Additional stainless steel smooth blade	27106
Coarse serrated blade	101801S
Smooth blade	101800S

FLOOR STANDING VERTICAL CUTTER MIXERS

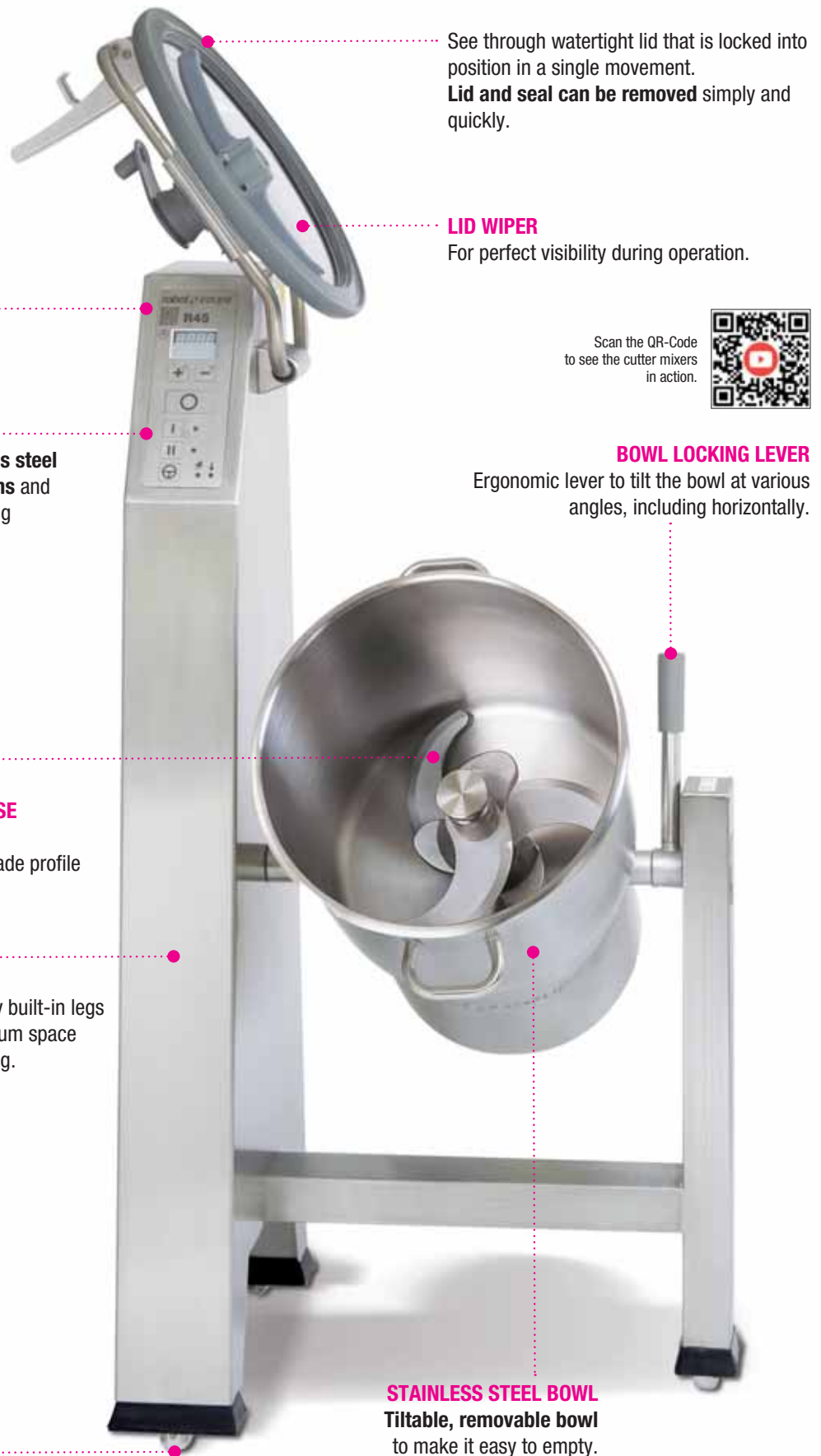

Easy Guide

CONTROL PANEL
0 to 15 minute **timer**, **stainless steel flush mounted control buttons** and **pulse control** for greater cutting precision.

See through watertight lid that is locked into position in a single movement.
Lid and seal can be removed simply and quickly.

LID WIPER
For perfect visibility during operation.

Scan the QR-Code to see the cutter mixers in action.



BOWL LOCKING LEVER
Ergonomic lever to tilt the bowl at various angles, including horizontally.

INNOVATION











STAINLESS STEEL BOWL-BASE BLADE ASSEMBLY
New Robot-Coupe patented blade profile for optimum cutting quality.

STAINLESS STEEL FRAME
All stainless steel with 3 sturdy built-in legs to ensure total stability, minimum space requirements and easy cleaning.

WHEELS INCLUDED
3 retractable wheels for easy moving and cleaning.

STAINLESS STEEL BOWL
Tiltable, removable bowl to make it easy to empty.

3 BLADES FOR BEST RESULTS

 <p>Smooth blade As standard</p>	 <p>COARSE CHOPPING</p>	 <p>FINE CHOPPING</p>	 <p>SAUCES, EMULSIONS</p>
 <p>Coarse serrated blade ESPECIALLY for grinding & kneading</p>	 <p>KNEADING</p>	 <p>GRINDING</p>	
 <p>Fine serrated blade ESPECIALLY for herbs & spices</p>	 <p>CHOPPING HERBS</p>	 <p>GRINDING SPICES</p>	

VACUUM FUNCTION **R-Vac®**

The **R-Vac®** is designed for vacuum processing to obtain results of incomparable quality for all delicate preparations such as fish mousse, fine stuffing, vegetable terrine, foie gras block terrine, ganache, etc.

The advantages of vacuum processing:

- Better preservation
- Better presentation
- Better development of aromas and flavours
- Better cooking



FLOOR STANDING VERTICAL CUTTER MIXERS



Quantities*



3 to 9 kg



3 to 12 kg



4 to 14 kg

2 SPEEDS 1 500 and 3 000 rpm

R 15



15 L

- Three phase

R 20



20 L

- Three phase

R 23



23 L

- Three phase



Quantities*



4 to 17 kg



6 to 27 kg



6 to 36 kg

2 SPEEDS 1 500 and 3 000 rpm

R 30



28 L

- Three phase

R 45



45 L

- Three phase

R 60



60 L

- Three phase

*Quantities processed at the same time

PERFORMANCE RATES

Models	Maximum capacity				Number of covers	Time
	Coarse chopping (up to)	Emulsions (up to)	Pastry/dough* (up to)	Grinding (up to)		
R 15	6 kg	9 kg	7.0 kg	7.0 kg	300 to 600	1 to 4 minutes
R 20	8 kg	12 kg	10.0 kg	10.0 kg	300 to 600	
R 23	10 kg	14 kg	11.5 kg	11.5 kg	600 to 1200	
R 30	12 kg	17 kg	14.0 kg	14.0 kg	600 to 1200	
R 45	18 kg	27 kg	22.5 kg	22.5 kg	1200+	
R 60	25 kg	36 kg	30.0 kg	30.0 kg	1200+	

*Amount of raised dough with 60% hydration

Find all our table-top models on page 80



R 15

Induction motor	✓
Power	3 000 W
Voltage	Three phase
Speed	1 500 rpm - 3 000 rpm
Pulse	✓
Bowl	15 L stainless steel
Blade	All stainless steel detachable, adjustable 3 smooth blade assembly - Included

R 20

	✓
Power	4 400 W
Voltage	Three phase
Speed	1 500 rpm - 3 000 rpm
Pulse	✓
Bowl	20 L stainless steel
Blade	All stainless steel detachable, adjustable 3 smooth blade assembly - Included

Choose your model:



Scan the QR-Code to see the cutter mixers in action.

Choose your options:

R 15	Ref.
R 15 400V/50/3	51491
R 15 380V/60/3	51494
R 15 230V/50/3	51495
R 15 220V/60/3	51493

R 20	Ref.
R 20 400V/50/3	51591
R 20 380V/60/3	51594
R 20 230V/50/3	51595
R 20 220V/60/3	51593

R 15 / R 20	
Options	Ref.
Stainless steel coarse serrated 3 blade assembly Especially for grinding & kneading	57098
Stainless steel fine serrated 3 blade assembly Especially for herbs & spices	57099
Additional stainless steel smooth 3 blade assembly	57097
Coarse serrated blade	59393
Fine serrated blade	59359
Smooth blade	59392
Vacuum adaptation kit R-Vac (without pump)	29996
Vacuum pump 550 W 16 m ² 230V/50/1	69012



R 15	
Optional additional mini bowls	Ref.
4.5 litre stainless steel bowl R 15 stainless steel smooth blade	27375
Stainless steel coarse serrated blade	27107
Additional stainless steel smooth blade	27106
Coarse serrated blade	101801S
Smooth blade	101800S

FLOOR STANDING VERTICAL CUTTER MIXERS



R 23

Induction motor	✓
Power	4 500 W
Voltage	Three phase
Speed	1 500 rpm - 3 000 rpm
Pulse	✓
IP85 control panel with digital timer	✓
Bowl	23 L stainless steel
Lid wiper	✓
Blade	All stainless steel detachable, adjustable 3 smooth blade assembly - Included
3 retractable wheels	✓



R 30

Induction motor	✓
Power	5 400 W
Voltage	Three phase
Speed	1 500 rpm - 3 000 rpm
Pulse	✓
IP85 control panel with digital timer	✓
Bowl	28 L stainless steel
Lid wiper	✓
Blade	All stainless steel detachable, adjustable 3 smooth blade assembly - Included
3 retractable wheels	✓

Choose your model:



Scan the QR-Code to see the cutter mixers in action.

R 23	Ref.
R 23 400V/50/3	51331C
R 23 380V/60/3	51334C
R 23 230V/50/3	51335C
R 23 220V/60/3	51333C

R 30	Ref.
R 30 400V/50/3	52331C
R 30 380V/60/3	52334C
R 30 230V/50/3	52335C
R 30 220V/60/3	52333C

Choose your options:

	R 23	R 30
Options	Ref.	Ref.
Stainless steel coarse serrated 3 blade assembly Especially for grinding & kneading	57070	57075
Stainless steel fine serrated 3 blade assembly Especially for herbs & spices	57072	57077
Additional stainless steel smooth 3 blade assembly	57069	57074
Coarse serrated blade	118294S	118286S
Fine serrated blade	118292S	118241S
Smooth blade	118217S	117950S
3-height GN1x1 adjustable trolley	49128	49128



R 45

Induction motor	✓
Power	10 000 W
Voltage	Three phase
Speed	1 500 rpm - 3 000 rpm
Pulse	✓
IP85 control panel with digital timer	✓
Bowl	45 L stainless steel
Lid wiper	✓
Blade	All stainless steel detachable, adjustable 3 smooth blade assembly - Included
3 retractable wheels	✓



R 60

Induction motor	✓
Power	11 000 W
Voltage	Three phase
Speed	1 500 rpm - 3 000 rpm
Pulse	✓
IP85 control panel with digital timer	✓
Bowl	60 L stainless steel
Lid wiper	✓
Blade	All stainless steel detachable, adjustable 3 smooth blade assembly - Included
3 retractable wheels	✓

Choose your model:



Scan the QR-Code to see the cutter mixers in action.

R 45	Ref.
R 45 400V/50/3	53331C
R 45 380V/60/3	53334C
R 45 230V/50/3	53335C
R 45 220V/60/3	53333C

R 60	Ref.
R 60 400V/50/3	54331C
R 60 380V/60/3	54334C
R 60 230V/50/3	54335C
R 60 220V/60/3	54333C

Choose your options:

Options	R 45	R 60
	Ref.	Ref.
Stainless steel coarse serrated 3 blade assembly Especially for grinding & kneading	57082	57092
Stainless steel fine serrated 3 blade assembly Especially for herbs & spices	57084	57095
Additional stainless steel smooth 3 blade assembly	57081	57091
Coarse serrated blade	118287S	118290S
Fine serrated blade	118243S	118245S
Smooth blade	117952S	117954S
3-height GN1x1 adjustable trolley	49128	49128

Robot Cook®

COOKING CUTTER BLENDER





The 1st professional Cooking Cutter Blender!

The Robot Cook[®] emulsifies, grinds, mixes, chops, blends and kneads to perfection. The heating temperature is variable, up to 140°C, and is accurate to the nearest degree. The large capacity bowl means that large quantities can be produced when needed.



Robot Cook®

THE KITCHEN ASSISTANT FOR CHEFS

Clever: Watertight lid including a no-splash safety function. Anti-vapour lid wiper so you can keep an eye on your preparation.



Ingenious: Special system to hold the blade in place so the bowl can be emptied safely.

Hygienic: All parts in contact with food can be easily removed and are dishwasher safe.

Easy Guide

Quiet: In the midst of the general hustle and bustle of the kitchen, Chefs appreciate how quiet it is.

Practical: The opening in the lid means ingredients can be added to the bowl without having to stop the appliance.

Efficient: Bowl scraper arm for ultra-fine, homogeneous preparations.

Functional: Large capacity 3.7 litre bowl for producing professional quantities.

Powerful: The powerful Robot Cook® features on a heavy duty commercial grade induction motor.

High-precision: Variable heating capacity up to 140°C, accurate to the nearest degree.



PROCESSING ZONE

Control dial
(to adjust settings)

SETTING ZONE

- Low and high heating capacity up to 140°C
- Variable speed from 500 to 3 500 rpm
- Timer

PROGRAMMING ZONE

- P** Programme
- △** Step button

PROCESSING ZONE

- 1** Turbo/pulse function: up to 4 500 rpm
- 2** Start button
- 3** Stop button

Robot Cook® COOKING CUTTER BLENDER

● COLD
● HOT
UP TO
140°C



Robot Cook®

Induction motor	✓
Power	1 800 W
Voltage	Single phase
Speed	<ul style="list-style-type: none"> • Variable speed from 100 to 3 500 rpm • High-speed turbo of 4 500 rpm • R-Mix blend speed 100 to 500 rpm • Intermittent slow speed blade rotation every 2 seconds
Heating temperature	Up to 140°
Pulse	✓
Bowl	3.7 L stainless steel
Scraper arm	✓
Wall mounted blade holder	✓

Blades Fine serrated blade for blender function
Included
Smooth blade for cutter function - **Included**
Blade cleaning tool - **Included**

Choose your model:



Scan the QR-Code to see the Robot Cook® in action.

Robot Cook®	Ref.
Robot Cook® 230V/50-60/1	43000R
Robot Cook® 230V/50/1 UK plug	43001R
Robot Cook® 230V/50/1 DK	43007R
Robot Cook® 120V/60/1	43009R

Choose your options:

Options	Ref.
Additional 230V bowl set (bowl + blade + lid + scraper)	39854
Additional 120V bowl set (bowl + blade + lid + scraper)	49131
Additional fine serrated blade for blender function	39691
Additional smooth blade for cutter function	49691

● EMULSIFY



● CHOP



● BLEND



● GRIND



● MIX



● KNEAD



Blixer®

TABLE-TOP Blixer®

FLOOR-STANDING Blixer®

p.102

p.112



THE SOLUTION FOR TEXTURE MODIFIED FOOD

The Blixer®, especially designed for the healthcare sector, turns raw products into texture modified foods.

All foods, whether raw or cooked, sweet or savoury, whether entrees or mains, dessert or cheese, can be eaten by everyone at the table.



TABLE-TOP Blixer®

INNOVATION

Blixer® ARM
For a more even **consistency**.
Easy to remove and clean
for **perfect hygiene**.



INDUCTION MOTOR

Very powerful, to withstand intensive use over a long period of time.

Easy Guide



Fine serrated blade.



OPENING

So that liquids and solid ingredients can be added **during use**.

LID

Equipped with a seal for **perfect watertightness**.



HIGH BOWL SHAFT

High bowl shaft to process **large liquid quantities**.

Standard speed of 3 000 rpm for **perfectly even consistency**.

WHY HAVE A SECOND PROCESSING BOWL?

- Better organisation in the kitchen
- Reduces waiting time between 2 wash-ups

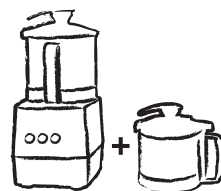

1 bowl for cold preparations



1 bowl for hot preparations





HEALTHCARE SECTOR - TEXTURE MODIFIED MEALS.....

Entrees



DUO OF RAW RED CABBAGE AND CELERIAC

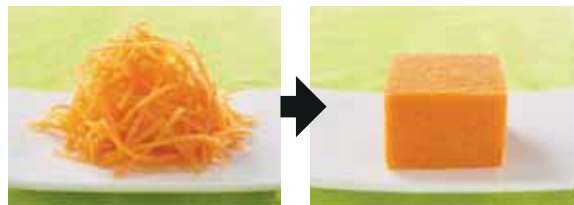

FRESHLY GRATED CARROTS

Mains

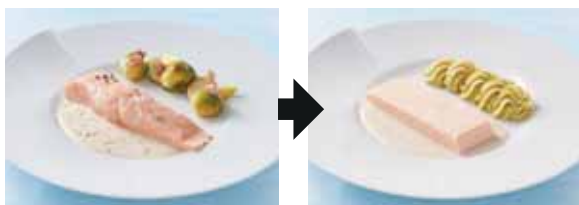

SALMON FILET AND CABBAGE



VEAL BLANQUETTE

Cheese

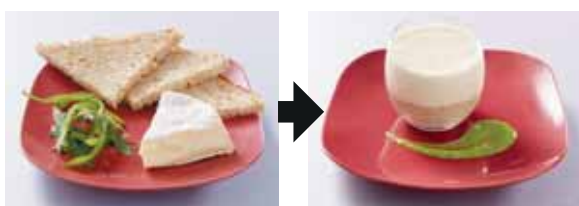

CAMEMBERT AND WHOLEMEAL BREAD

Desserts

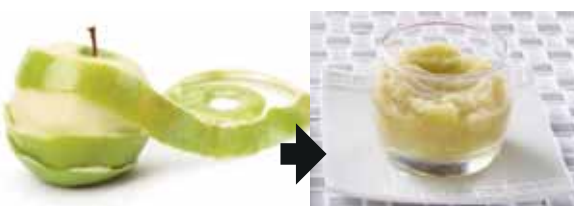

RAW GRANNY SMITH APPLE COMPOTE

HOW TO CHOOSE YOUR Blixer®

1 > Calculate the total weight of the texture-modified portions required.

	Average portion	Number of portions required	Total weight
Entree	80 g	X Portions = g
Meat / fish	100 g	X Portions = g
Vegetables / Carbs	200 g	X Portions = g
Dessert	80 g	X Portions = g

Number of 200 g portions

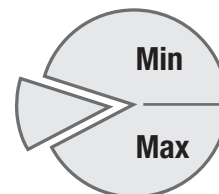

2 > Refer to the indications of the amounts processed per operation given in the product description.

RESTAURANTS - GASTRONOMY

It didn't take long for traditional and Asian food chefs to adopt the Blixer® for all their preparations:

Emulsions, appetizers, tapenade, hummus, tarama, pesto, etc.



Dry grinding, special "powders" for dry and dehydrated foods



[BACK TO SUMMARY](#)

TABLE-TOP Blixer®

Number of 200 g portions
Quantities processed per operation

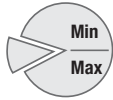

Single portion model

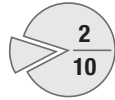

0.3 to 2 kg

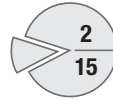

0.4 to 3 kg

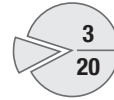

0.5 to 3.8 kg

VARIABLE SPEED from 300 to 3 500 rpm

Blixer® 4 V.V.

4.5 L



- Single phase

Blixer® 5 V.V.

NEW

5.9 L



- Single phase

2 SPEEDS 1 500 and 3 000 rpm

Blixer® 4 - 2V

4.5 L



- Three phase

Blixer® 5 - 2V

NEW

5.9 L



- Three phase

1 SPEED 3 000 rpm

Blixer® 2

2.9 L



- Single phase

Blixer® 3

3.7 L



- Single phase

Blixer® 4 - 1V

4.5 L



- Single phase

Blixer® 5 - 1V

NEW

5.9 L



- Single phase

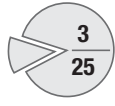

0.6 to 4.8 kg

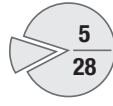

1 to 5.5 kg

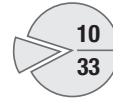

2 to 6.5 kg

VARIABLE SPEED from 300 to 3 500 rpm

Blixer® 7 V.V.



- Single phase

Blixer® 8 V.V.



- Single phase

Blixer® 10 V.V.



- Single phase

2 SPEEDS 1 500 and 3 000 rpm

Blixer® 7



- Three phase

Blixer® 8



- Three phase

Blixer® 10



- Three phase

PERFORMANCE RATES

Models	Quantities processed (kg)			Number of 200 g portions
	Bowl capacity (litres)	Min	Max	
Blixer® 2	2.9	Single portion model		
Blixer® 3	3.7	0.3	2	2 to 10
Blixer® 4	4.5	0.4	3	2 to 15
Blixer® 5 - 5 V.V.	5.9	0.5	3.8	3 to 20
Blixer® 7 - 7 V.V.	7.5	0.6	4.8	3 to 25
Blixer® 8 - 8 V.V.	8	1	5.5	5 to 28
Blixer® 10 - 10 V.V.	11.5	2	6.5	10 to 33

Find all our floor standing models on page 114

TABLE-TOP Blixer®



Blixer® 2

Induction motor	✓
Power	700 W
Voltage	Single phase
Speed	3 000 rpm
Pulse	✓
Motor base	Composite material
Bowl	2.9 L stainless steel
Watertight lid	✓
Blixer® arm	✓
Blade	Stainless steel fine serrated blade with removable cap Included Blade cleaning tool - Included
Number of 200 g portions	Single portion



Blixer® 3

Induction motor	✓
Power	750 W
Voltage	Single phase
Speed	3 000 rpm
Pulse	✓
Motor base	Composite material
Bowl	3.7 L stainless steel
Watertight lid	✓
Blixer® arm	✓
Blade	Stainless steel fine serrated blade with removable cap Included Blade cleaning tool - Included
Number of 200 g portions	2-10



Blixer® 4 - 1V

Induction motor	✓
Power	900 W
Voltage	Single phase
Speed	3 000 rpm
Pulse	✓
Motor base	Metal
Bowl	4.5 L stainless steel
Watertight lid	✓
Blixer® arm	✓
Blade	Stainless steel fine serrated blade with removable cap Included Blade cleaning tool - Included
Number of 200 g portions	2-15

Choose your model:



Scan the QR Code to see the Blixer® in action.

Blixer® 2	Ref.
Blixer® 2 230V/50/1	33228
Blixer® 2 230V/50/1 UK plug	33232
Blixer® 2 230V/50/1 DK	33229
Blixer® 2 220V/60/1	33233
Blixer® 2 120V/60/1	33234

Blixer® 3	Ref.
Blixer® 3 230V/50/1	33197
Blixer® 3 230V/50/1 UK plug	33198
Blixer® 3 230V/50/1 DK	33200
Blixer® 3 220V/60/1	33201
Blixer® 3 120V/60/1	33202

Blixer® 4 - 1V	Ref.
Blixer® 4-1V 230V/50/1	33208
Blixer® 4-1V 230V/50/1 UK plug	33209
Blixer® 4-1V 220V/60/1	33211
Blixer® 4-1V 120V/60/1	33210

Choose your options:

Options	Blixer® 2		Blixer® 3	
	Ref.		Ref.	
Complete Blixer® bowl, blade, lid and scraper	27369		27337	
Additional fine serrated blade	27370		27447	
Coarse serrated blade	27371		27448	



Blixer® 4 - 2V

Induction motor	✓
Power	1 000 W
Voltage	Three phase
Speed	1 500 rpm - 3 000 rpm
Pulse	✓
Motor base	Metal
Bowl	4.5 L stainless steel
Watertight lid	✓
Blixer® arm	✓
Blade	Stainless steel fine serrated blade with removable cap Included Blade cleaning tool - Included
Number of 200 g portions	2-15

Blixer® 4 V.V.

Induction motor	✓
Power	1 100 W
Voltage	Single phase
Speed	300 to 3 500 rpm
Pulse	✓
Motor base	Metal
Bowl	4.5 L stainless steel
Watertight lid	✓
Blixer® arm	✓
Blade	Stainless steel fine serrated blade with removable cap Included Blade cleaning tool - Included
Number of 200 g portions	2-15



Choose your model:



Scan the QR Code to see the Blixer® in action.

Blixer® 4 - 2V	Ref.
Blixer® 4 2-V 400V/50/3	33215
Blixer® 4 2-V 380V/60/3	33217
Blixer® 4 2-V 220V/60/3	33216
Blixer® 4 2-V 220V/50/3	33218

Blixer® 4 V.V.	Ref.
Blixer® 4 V.V. 230V/50-60/1	33280
Blixer® 4 V.V. 230V/50-60/1 UK plug	33281

It is advisable to use a type A or type B GFCI.

Choose your options:

Blixer® 4 all models		
Options	Ref.	
Complete Blixer® bowl, blade, lid and scraper	27338	
Additional fine serrated blade	27449	
Coarse serrated blade	27450	

BACK TO SUMMARY

TABLE-TOP Blixer®



Blixer® 5 - 1V

Blixer® 5 - 2V

Blixer® 5 V.V.

Induction motor	✓	✓	✓
Power	1 500 W	1 500 W	1 500 W
Voltage	Single phase	Three phase	Single phase
Speed	3 000 rpm	1 500 rpm - 3 000 rpm	300 to 3 500 rpm
Timer	✓	✓	✓
Pulse	✓	✓	✓
Motor base	Metal	Metal	Metal
Bowl	5.9 L stainless steel	5.9 L stainless steel	5.9 L stainless steel
Watertight lid	✓	✓	✓
Blixer® arm	✓	✓	✓
Blade	Stainless steel fine serrated blade with removable cap Included Blade cleaning tool - Included, coming soon	Stainless steel fine serrated blade with removable cap Included Blade cleaning tool - Included, coming soon	Stainless steel fine serrated blade with removable cap Included Blade cleaning tool - Included, coming soon
Number of 200 g portions	3-20	3-20	3-20

Choose your model:



Scan the QR Code to see the Blixer® in action.

Blixer® 5 - 1V	Ref.
Blixer® 5 1-V 230V/50/1	33251
Blixer® 5 1-V 220V/60/1	33250

Blixer® 5 - 2V	Ref.
Blixer® 5 2-V 400V/50/3	33259
Blixer® 5 2-V 380V/60/3	33258
Blixer® 5 2-V 220V/60/3	33262

Blixer® 5 V.V.	Ref.
Blixer® 5 V.V. 230V/50-60/1	33266
Blixer® 5 V.V. 230V/50-60/1 UK plug	33265

Choose your options:

Blixer® 5 all models	
Options	Ref.
Complete Blixer® bowl, blade, lid and scraper	27322
Additional fine serrated blade	27310
Coarse serrated blade	27311
Blade cleaning tool - Coming soon	49258



Blixer® 7

Induction motor	✓
Power	1 500 W
Voltage	Three phase
Speed	1 500 rpm - 3 000 rpm
Timer	✓
Pulse	✓
Motor base	Metal
Bowl	7.5 L stainless steel
Watertight lid	✓
Blixer® arm	✓
Blade	Stainless steel fine serrated blade with removable cap Included Blade cleaning tool - Included, coming soon

Number of 200 g portions 3-25

Choose your model:



Scan the QR Code to see the Blixer® in action.

Blixer® 7	Ref.
Blixer® 7 400V/50/3	33269

Blixer® 7 V.V.

Induction motor	✓
Power	1 500 W
Voltage	Single phase
Speed	300 to 3 500 rpm
Timer	✓
Pulse	✓
Motor base	Metal
Bowl	7.5 L stainless steel
Watertight lid	✓
Blixer® arm	✓
Blade	Stainless steel fine serrated blade with removable cap Included Blade cleaning tool - Included, coming soon

3-25

Blixer® 7 V.V.	Ref.
Blixer® 7 V.V. 230V/50-60/1	33295
Blixer® 7 V.V. 230V/50-60/1 UK plug	33298



Choose your options:

Blixer® 7 all models	
Options	Ref.
Complete Blixer® bowl, blade, lid and scraper	27323
Additional composite blade assembly with stainless steel fine-serrated blades	27316
Composite blade assembly with stainless steel coarse-serrated blades	27317
Stainless steel fine serrated 2 blade assembly	27313
Stainless steel coarse serrated 2 blade assembly - Especially for grinding	27314
Lower fine-serrated blade	49166
Upper fine-serrated blade	49167
Lower coarse-serrated blade	49168
Upper coarse-serrated blade	49169
Blade cleaning tool - Coming soon	49258

TABLE-TOP Blixer®



Blixer® 8

Induction motor	✓
Power	2 200 W
Voltage	Three phase
Speed	1 500 rpm - 3 000 rpm
Pulse	✓
Bowl	8 L stainless steel
See-through watertight lid	✓
Removable Blixer® arm	✓
Blade	All stainless steel detachable adjustable fine serrated blade assembly - Included
Number of 200 g portions	5-28

Choose your model:

Blixer® 8	Ref.
Blixer® 8 400V/50/3	21311
Blixer® 8 380V/60/3	21314
Blixer® 8 230V/50/3	21315
Blixer® 8 220V/60/3	21313

Choose your options:

Options	Ref.
Complete Blixer® bowl, blade, lid and scraper	27387
Fine serrated 2 blade assembly	27377
Additional fine serrated blade	59282

Blixer® 8 all models



Blixer® 8 V.V.

Induction motor	✓
Power	2 200 W
Voltage	Single phase
Speed	300 to 3 500 rpm
Pulse	✓
Bowl	8 L stainless steel
See-through watertight lid	✓
Removable Blixer® arm	✓
Blade	All stainless steel detachable adjustable fine serrated blade assembly - Included
Number of 200 g portions	5-28

Blixer® 8 V.V.	Ref.
Blixer® 8 V.V. 200-240/50-60/1	21305

 It is advisable to use a type A or type B GFCI.



Blixer® 10

Induction motor	✓
Power	2 600 W
Voltage	Three phase
Speed	1 500 rpm - 3 000 rpm
Pulse	✓
Bowl	11.5 L stainless steel
See-through watertight lid	✓
Removable Blixer® arm	✓
Blade	All stainless steel detachable adjustable fine serrated 3 blade assembly - Included
Number of 200 g portions	10-33

Choose your model:

Blixer® 10	Ref.
Blixer® 10 400V/50/3	21411
Blixer® 10 380V/60/3	21414
Blixer® 10 230V/50/3	21415
Blixer® 10 220V/60/3	21413

Blixer® 10 V.V.

Induction motor	✓
Power	2 600 W
Voltage	Single phase
Speed	300 to 3 500 rpm
Pulse	✓
Bowl	11.5 L stainless steel
See-through watertight lid	✓
Removable Blixer® arm	✓
Blade	All stainless steel detachable adjustable fine serrated 3 blade assembly - Included
Number of 200 g portions	10-33

Blixer® 10 V.V.	Ref.
Blixer® 10 V.V. 200-240/50-60/1	21405

 It is advisable to use a type A or type B GFCI.

Choose your options:

Blixer® 10 all models		
Options	Ref.	
Complete Blixer® bowl, blade, lid and scraper	27388	
Additional stainless steel fine serrated blade assembly	27378	
Additional fine serrated blade	59282	

NORMAL TEXTURE



MODIFIED TEXTURE



FINGER FOODS



FLOOR-STANDING Blixer®

INNOVATION

Blixer® ARM

To improve turbulence and thus produce finer-textured preparations.



Easy Guide

CONTROL PANEL

0 to 15 minute **timer**, stainless steel flush-mounted control buttons and **pulse** control for greater cutting precision.

INNOVATION

BOWL-BASE TWIN-BLADE ASSEMBLY

A Robot-Coupe® exclusivity to obtain a perfectly smooth consistency, even with small quantities.

STAINLESS STEEL FRAME

All stainless steel with 3 sturdy built in legs to ensure total stability, minimum space requirements and easy cleaning.



See through watertight lid requiring a single movement to lock it into position. **Lid and seal can be removed** simply and quickly.

LID WIPER

For perfect visibility during operation.

BOWL LOCKING LEVER

Ergonomic lever to tilt the bowl at various angles, including horizontally.

WHEELS INCLUDED
3 retractable wheels for easy moving and cleaning.

INNOVATION

STAINLESS STEEL BOWL

Tiltable, removable bowl, a Robot-Coupe exclusivity.
Capacity: 23, 28, 45 or 60 litres, depending on the model.



HEALTHCARE SECTOR - TEXTURE MODIFIED MEALS

Entrees



DUO OF RAW RED CABBAGE AND CELERIAC

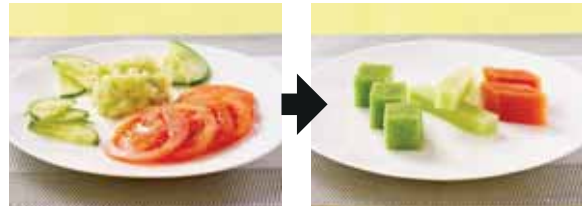

CUCUMBER AND TOMATO VARIATION

Mains



WHITE FISH AND RADISH QUENELLES

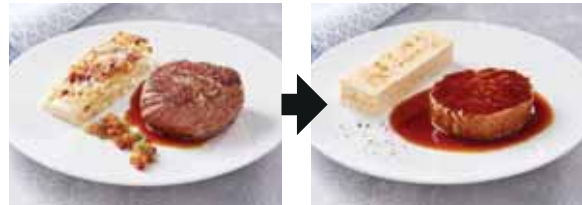

STEAK AND POTATO GRATIN

Cheese

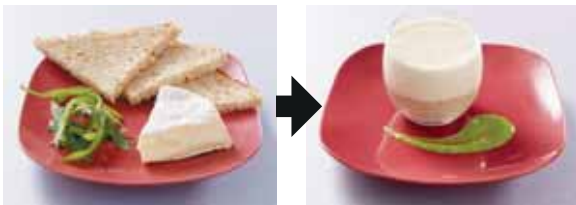

CAMEMBERT AND WHOLEMEAL BREAD

Dessert

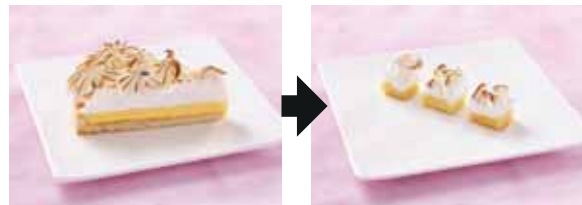

LEMON TART

RESTAURANTS - GASTRONOMY

It didn't take long for traditional and Asian food chefs to adopt the Blixer® for all their preparations:

Emulsions, appetizers, tapenade, hummus, tarama, pesto, etc.



Dry grinding, special "powders" for dry and dehydrated foods



FLOOR-STANDING Blixer®

Number of 200 g portions
Quantities processed per operation

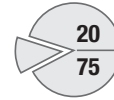
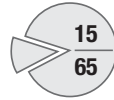
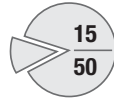
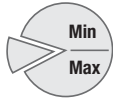

3 to 10 kg

3 to 13 kg

4 to 15 kg

2 SPEEDS 1 500 and 3 000 rpm

Blixer® 15



15 L

• 3 phase

Blixer® 20



20 L

• 3 phase

Blixer® 23



23 L

• 3 phase

Number of 200 g portions
Quantities processed per operation

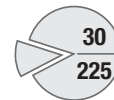
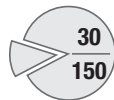
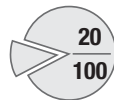
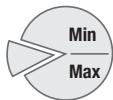

4 to 20 kg

6 to 30 kg

6 to 45 kg

2 SPEEDS 1 500 and 3 000 rpm

Blixer® 30



28 L

• 3 phase

Blixer® 45



45 L

• 3 phase

Blixer® 60



60 L

• 3 phase

PERFORMANCE RATES

Models	Quantities processed (kg)			Number of 200 g portions
	Bowl capacity (litres)	Min	Max	
Blixer® 15	15	3	10	15 to 50
Blixer® 20	20	3	13	15 to 65
Blixer® 23	23	4	15	20 to 75
Blixer® 30	28	4	20	20 to 100
Blixer® 45	45	6	30	30 to 150
Blixer® 60	60	6	45	30 to 225

Find all our table-top models on page 104



Blixer® 15

Induction motor	✓
Power	3 000 W
Voltage	Three phase
Speed	1 500 rpm - 3 000 rpm
Pulse	✓
Bowl	15 L stainless steel
See-through watertight lid	✓
Removable Blixer® arm	✓
Blade	All stainless steel detachable adjustable fine serrated 3 blade assembly - Included
Number of 200 g portions	15-50

Blixer® 20

Induction motor	✓
Power	4 400 W
Voltage	Three phase
Speed	1 500 rpm - 3 000 rpm
Pulse	✓
Bowl	20 L stainless steel
See-through watertight lid	✓
Removable Blixer® arm	✓
Blade	All stainless steel detachable adjustable fine serrated 3 blade assembly - Included
Number of 200 g portions	15-65

Choose your model:

Blixer® 15	Ref.
Blixer® 15 400V/50/3	51511
Blixer® 15 380V/60/3	51514
Blixer® 15 230V/50/3	51515
Blixer® 15 220V/60/3	51513

Blixer® 20	Ref.
Blixer® 20 400V/50/3	51611
Blixer® 20 380V/60/3	51614
Blixer® 20 230V/50/3	51615
Blixer® 20 220V/60/3	51613

Choose your options:

Options	Blixer® 15		Blixer® 20	
	Ref.		Ref.	
Complete Blixer® bowl, blade, lid and scraper	57065		57066	
Fine serrated 3 blade assembly	57102		57102	
Additional fine serrated blade	59359		59359	



Blixer® 23

Induction motor	✓
Power	4 500 W
Voltage	Three phase
Speed	1 500 rpm - 3 000 rpm
Pulse	✓
IP65 control panel with digital timer	✓
Bowl	23 L stainless steel
See-through lid	✓
Lid wiper	✓
Blixer® arm	✓
Blade	All stainless steel detachable adjustable fine serrated blade assembly - Included
3 retractable wheels	✓
Number of portions	20-75

Blixer® 30

Induction motor	✓
Power	5 400 W
Voltage	Three phase
Speed	1 500 rpm - 3 000 rpm
Pulse	✓
IP65 control panel with digital timer	✓
Bowl	28 L stainless steel
See-through lid	✓
Lid wiper	✓
Blixer® arm	✓
Blade	All stainless steel detachable adjustable fine serrated blade assembly - Included
3 retractable wheels	✓
Number of portions	20-100

Choose your model:

	Blixer® 23	Ref.
Blixer® 23 400V/50/3		51341
Blixer® 23 230V/50/3		51345

	Blixer® 30	Ref.
Blixer® 30 400V/50/3		52341
Blixer® 30 230V/50/3		52345

Choose your options:

	Blixer® 23		Blixer® 30	
Options	Ref.		Ref.	
Additional stainless steel fine serrated blade	57071		57076	
Fine serrated blade	118292S		118241S	



Blixer® 45

Induction motor	✓
Power	10 000 W
Voltage	Three phase
Speed	1 500 rpm - 3 000 rpm
Pulse	✓
IP65 control panel with digital timer	✓
Bowl	45 L stainless steel
See-through lid	✓
Lid wiper	✓
Blixer® arm	✓
Blade	All stainless steel detachable adjustable fine serrated blade assembly - Included
3 retractable wheels	✓
Number of portions	30-150

Choose your model:

Blixer® 45	Ref.
Blixer® 45 400V/50/3	53341
Blixer® 45 230V/50/3	53345

Blixer® 60

Induction motor	✓
Power	11 000 W
Voltage	Three phase
Speed	1 500 rpm - 3 000 rpm
Pulse	✓
IP65 control panel with digital timer	✓
Bowl	60 L stainless steel
See-through lid	✓
Lid wiper	✓
Blixer® arm	✓
Blade	All stainless steel detachable adjustable fine serrated blade assembly - Included
3 retractable wheels	✓
Number of portions	30-225

Blixer® 60	Ref.
Blixer® 60 400V/50/3	54341
Blixer® 60 230V/50/3	54345

Choose your options:

	Blixer® 45	Blixer® 60
Options	Ref.	Ref.
Additional stainless steel fine serrated blade	57083	57093
Fine serrated blade	118243S	118245S

IMMERSION BLENDERS



FIVE PRODUCT RANGES AT THE FOREFRONT OF INNOVATION

Whatever their size, Robot-Coupe Immersion Blenders can mix, blend, emulsify, whip and knead in just a few seconds! Their performance in terms of hygiene, simplicity of use, versatility, service life and return on investment makes them the best on the market.



IMMERSION BLENDERS

ERGONOMICS

Ergonomic handle for greater convenience.

PERFORMANCE

High-power motor: **+20%** for greater efficiency.
Increased performance to **optimise blending time**.

Easy Guide

LONG SERVICE LIFE

Stainless steel motor base for intensive use.

INNOVATION

CLEANING

Removable stainless steel bell and blade for easy cleaning and maintenance.



Scan the QR-Code to see the immersion blenders in action.



For the MP V.V. and MP Combi models, **more ergonomic variable speed button** for greater convenience.

INNOVATION



ERGONOMICS

The lug on the motor base can be used to rest the immersion blender on the rim of the pan to make it easier to handle and relieve some of the strain.

The lug allows to wind the cord to make it easier to store and prevent wear and tear.

NEW



New EasyGrip removable handle. The machine's weight is distributed better making it even easier to use!



AFTER SALES SERVICE: DETACHABLE POWER CORD

- The new patented "EasyPlug" system** means that the power cord can be easily replaced during after-sales servicing.
- Indicator light:** quick detection of power cord failure. The green light comes on if the cord is undamaged and correctly plugged in on both sides (wall socket and EasyPlug).





SOUPS



SAUCES



COULIS



EMULSIONS



The AeroMix tool is available on the Mini and MicroMix® product lines.

DISCOVER OUR PAN SUPPORTS TO RELIEVE STRAIN

Page 130



[BACK TO SUMMARY](#)

IMMERSION BLENDERS

MINI

Mini MP
See page 126



220 W MicroMix®
240 W Mini MP 160 V.V.
270 W Mini MP 190 V.V.
290 W Mini MP 240 V.V.

COMPACT

CMP
See page 128

NEW



310 W CMP 250 V.V.
350 W CMP 300 V.V.
400 W CMP 350 V.V.
420 W CMP 400 V.V.

15 litres 30 litres 45 litres 73 litres

LARGE

MP
See page 131



440 W MP 350 Ultra
500 W MP 450 Ultra
750 W MP 550 Ultra
850 W MP 600 Ultra
1 000 W MP 800 Turbo

50 litres 100 litres 200 litres 300 litres 400 litres

For emulsions

For small preparations

For restaurants & cafés

For intensive use
Institutions and caterers

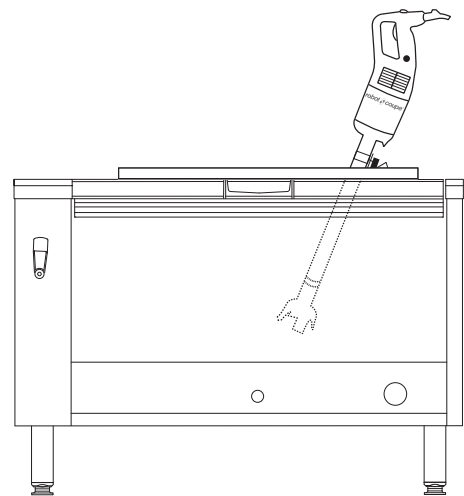
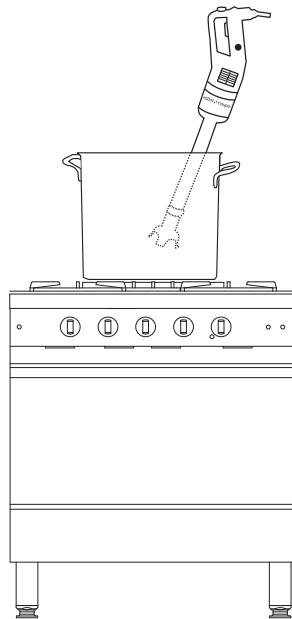
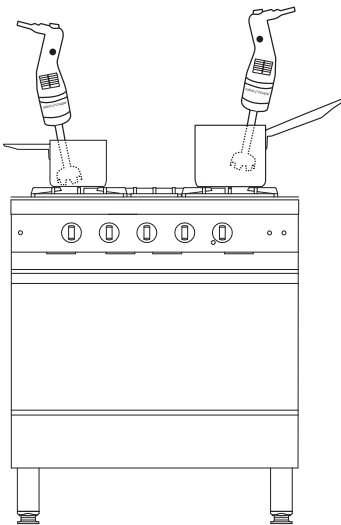

COMBI

MINI MP - CMP - MP Ultra - MP FW Ultra

See page 135

							
190 mm	185 mm 240 mm	250 mm	220 mm 300 mm	350 mm	280 mm 450 mm		
270 W Mini MP 190 Combi	290 W Mini MP 240 Combi	310 W CMP 250 Combi	350 W CMP 300 Combi	440 W MP 350 Combi Ultra	500 W MP 450 Combi Ultra	500 W MP 450 FW Ultra	500 W MP 450 XL FW Ultra
		15 litres	30 litres	50 litres	100 litres	100 litres	100 litres
For small preparations		For restaurants & cafés		For intensive use Institutions and caterers			

CLEANING

Blade and bell easy to remove.



To comply with the HACCP requirement, we advise users to store the bell and blade in a cool room after cleaning.

STRAIN RELIEF

Easy-to-use pan supports to relieve strain during use.

- 1 universal stainless steel pan support:**
 - To be attached to the edge of the pan.
- 2 3 adjustable stainless steel pan supports:**
 - Pan diameter: 330 to 650 mm
 - Pan diameter: 500 to 1000 mm
 - Pan diameter: 850 to 1300 mm



MICROMIX®

The top choice of chefs. Only a few seconds are needed to make a perfect emulsion!

PERFORMANCE

Bell design reduces blending time. **Powerful and quiet.**

HEAVY DUTY

All stainless steel tube, bell, motor housing and tools.

ERGONOMICS

High precision, easy to access variable speed button. Extendable coiled power cord for easier handling. Maximum length 1300 mm. Ideal for use just before serving.



CLEANING

The tube and attachments can be removed for easy cleaning. Practical storage for the immersion blender and attachments.



INNOVATION

AEROMIX

Patented tool designed to make instant light fluffy **emulsions** that always keep their shape on the plate.



BLADE

For making **small portions** of all your favourite **soups and sauces**.



ONLY A FEW SECONDS ARE NEEDED TO MAKE A PERFECT EMULSION!





Wall support



MicroMix®

Power	220 W
Voltage	Single phase
Speed	1 500 to 14 000 rpm
Blade and shaft	Length 165 mm - all stainless steel
Removable blade	✓
Removable foot	✓
Dimensions	Length 430 mm, Ø 61 mm
Gross weight	1.4 kg
Accessories	Stainless steel Aeromix - Included Wall support - Included



Scan the QR-Code to see the immersion blenders in action.



Special Merchandising Pack to display 6 MicroMix® in showrooms.

	Ref.	Sales unit		Packaging unit	
Micromix 230V/50/1	34900	1		1	
MicroMix 230V/50/1 UK plug	34901	1		1	
MicroMix 220V/60/1	34904	1		1	
Pack of 6 Micromix 230V/50/1	34950	1		6	
Pack of 6 MicroMix 230V/50/1 UK plug	34951	1		6	



MINI PRODUCT RANGE

Minimum size, maximum performance!

For sauces, emulsions and small preparations.

HANDLE DESIGN

for easy grip and **effortless use**.



Detachable stainless steel blade and shaft for perfect hygiene.



Blade designed for optimum blending.



VARIABLE SPEED BUTTON

Easy to see and adjust.

STAINLESS STEEL MOTOR HOUSING

To make the immersion blender last longer.

INNOVATION

AEROMIX

Patented emulsifying tool designed to make instant light fluffy **emulsions** that always keep their shape on the plate.



BLADE



AEROMIX

For emulsions





Mini MP 160 V.V.

Power	240 W
Voltage	Single phase
Speed	2 000 to 12 500 rpm
Blade, bell and shaft	Length 160 mm - all stainless steel
Removable blade	✓
Removable bell	No
Removable foot	✓
Dimensions	Length 455 mm, Ø 78 mm
Gross weight	2.4 kg
Accessories	Stainless steel Aeromix Included Wall support - Included

Mini MP 190 V.V.

Power	270 W
Voltage	Single phase
Speed	2 000 to 12 500 rpm
Blade, bell and shaft	Length 190 mm - all stainless steel
Removable blade	✓
Removable bell	✓
Removable foot	✓
Dimensions	Length 485 mm, Ø 78 mm
Gross weight	2.5 kg
Accessories	Stainless steel Aeromix Included Wall support - Included

Mini MP 240 V.V.

Power	290 W
Voltage	Single phase
Speed	2 000 to 12 500 rpm
Blade, bell and shaft	Length 240 mm - all stainless steel
Removable blade	✓
Removable bell	✓
Removable foot	✓
Dimensions	Length 535 mm, Ø 78 mm
Gross weight	2.5 kg
Accessories	Stainless steel Aeromix Included Wall support - Included

Choose your model:



Scan the QR-Code to see the immersion blenders in action.

Mini MP 160 V.V.	Ref.
Mini MP 160 V.V. 230V/50/1	34740
Mini MP 160 V.V. 230V/50/1 UK plug	34741
Mini MP 160 V.V. 220V/60/1	34744
Mini MP 160 V.V. 120V/60/1	34745

Mini MP 190 V.V.	Ref.
Mini MP 190 V.V. 230V/50/1	34750
Mini MP 190 V.V. 230V/50/1 UK plug	34751
Mini MP 190 V.V. 220V/60/1	34754
Mini MP 190 V.V. 120V/60/1	34755

Mini MP 240 V.V.	Ref.
Mini MP 240 V.V. 230V/50/1	34760
Mini MP 240 V.V. 230V/50/1 UK plug	34761
Mini MP 240 V.V. 220V/60/1	34764
Mini MP 240 V.V. 120V/60/1	34765



Whisk function
Mini MP 190 Combi
See page 136



Whisk function
Mini MP 240 Combi
See page 136

CMP COMPACT PRODUCT RANGE

Compact, easy-to-handle, high-performance.
For restaurants & cafés



POWERFUL

High-Power motor:

+15 % for greater efficiency.



PERFORMANCE

Optimum blending for a fine textured end product in a minimum amount of time.



LONG SERVICE LIFE

Stainless steel motor base for intensive use.



COMFORT

Variable speed for greater flexibility when making sophisticated preparations.



ERGONOMICS

Light, compact, easy-to-handle appliance.

The lug on the motor base can be used to rest the mixer on the rim of a pan to make it easier to handle and remove some of the strain.

The lug allows to wind the cord to make it easier to store and prevent wear and tear.



CLEANING

Removable stainless steel bell and blade for easy cleaning and maintenance.

AFTER SALES SERVICE: DETACHABLE POWER CORD

- 1 The new patented "EasyPlug" system** means that the power cord can be easily replaced during after-sales servicing.
- 2 Indicator light:** rapid detection of power cord failure. The green light comes on if the cord is undamaged and correctly plugged in on both sides (wall socket and EasyPlug).





CMP 250 V.V. CMP 300 V.V. CMP 350 V.V. CMP 400 V.V.

Power	310 W	350 W	400 W	420 W
Voltage	Single phase	Single phase	Single phase	Single phase
Speed	2 300 to 9 600 rpm (self regulating system)	2 300 to 9 600 rpm (self regulating system)	2 300 to 9 600 rpm (self regulating system)	2 300 to 9 600 rpm (self regulating system)
Blade, bell and shaft	Length 250 mm - all stainless steel	Length 300 mm - all stainless steel	Length 350 mm - all stainless steel	Length 400 mm - all stainless steel
Removable blade	✓	✓	✓	✓
Removable bell	✓	✓	✓	✓
Removable foot	No	No	No	No
Dimensions	Length 650 mm, Ø 94 mm	Length 660 mm, Ø 94 mm	Length 700 mm, Ø 94 mm	Length 763 mm, Ø 94 mm
Gross weight	3.9 kg	3.9 kg	4.1 kg	4.1 kg
Accessories	Wall support - Included	Wall support - Included	Wall support - Included	Wall support - Included

Choose
your model:



Scan the QR-Code
to see the immersion
blenders in action.

CMP 250 V.V. / CMP 300 V.V.	Ref.
CMP 250 V.V. 230V/50/1	34240B
CMP 250 V.V. 230V/50/1 UK plug	34241B
CMP 250 V.V. 220V/60/1	34244B
CMP 250 V.V. 120V/60/1	34245B
CMP 300 V.V. 230V/50/1	34230B
CMP 300 V.V. 230V/50/1 UK plug	34231B
CMP 300 V.V. 220V/60/1	34234B
CMP 300 V.V. 120V/60/1	34235B

CMP 350 V.V. / CMP 400 V.V.	Ref.
CMP 350 V.V. 230V/50/1	34250B
CMP 350 V.V. 230V/50/1 UK plug	34251B
CMP 350 V.V. 220V/60/1	34254B
CMP 350 V.V. 120V/60/1	34255B
CMP 400 V.V. 230V/50/1	34260B
CMP 400 V.V. 230V/50/1 UK plug	34261B



Whisk function

CMP 250 Combi

See page 137



Whisk function

CMP 300 Combi

See page 137

MP/CMP PAN SUPPORTS

Pan supports reduce MSD risks, relieve strain and make it easier to control preparations.

They enable the immersion blender to be tilted effortlessly or left to do the job by itself.

Made entirely of stainless steel, they can be removed completely, are easy to clean and practical to use.

1 Universal pan support: Fits all pan sizes.



2 Adjustable pan supports:

Three pan supports are available as an option. They adapt to the size of the pan:

- pan Ø from 330 mm to 650 mm.
- pan Ø from 500 mm to 1 000 mm.
- pan Ø from 850 mm to 1 300 mm.



Stainless steel pan supports

1 universal stainless steel pan support 1	Ref.
To be attached to the edge of the pan.	27358
3 adjustable stainless steel pan supports 2	Ref.
For 330 to 650 mm diameter pans	27363
For 500 to 1000 mm diameter pans	27364
For 850 to 1300 mm diameter pans	27365

MP ULTRA LARGE PRODUCT RANGE

Even better performance and ergonomics!

ERGONOMICS

Ergonomic handle for greater convenience.

PERFORMANCE

High-Power motor: +20% for greater efficiency. Increased performance to optimise blending time.

LONG SERVICE LIFE

Stainless steel motor base for intensive use.



Easy Guide



CLEANING

Removable stainless steel bell and blade for easy cleaning and maintenance.



Scan the QR-Code to see the immersion blenders in action.



For the MP V.V. and MP Combi models, **more ergonomic variable speed button** for greater convenience.

INNOVATION



ERGONOMICS

The lug on the motor base can be used to rest the immersion blender on the rim of a pan to make it easier to handle and remove some of the strain.

The lug allows to wind the cord to make it easier to store and prevent wear and tear.

NEW



New EasyGrip removable handle. The machine's weight is distributed better making it even easier to use!

AFTER SALES SERVICE: DETACHABLE POWER CORD

- 1 The new patented "EasyPlug" system** means that the power cord can be easily replaced during after-sales servicing.
- 2 Indicator light:** rapid detection of power cord failure. The green light comes on if the cord is undamaged and correctly plugged in on both sides (wall socket and EasyPlug).





MP 350 Ultra

Power	440 W
Voltage	Single phase
Speed	9 500 rpm
Blade, bell and shaft	Length 350 mm - all stainless steel
Removable blade	✓
Removable bell	✓
Removable foot	No
EasyPlug	✓
Dimensions	Length 740 mm, Ø 125 mm
Gross weight	6.2 kg
Accessories	Wall support - Included



MP 350 Ultra V.V.

Power	440 W
Voltage	Single phase
Speed	1 500 to 9 000 rpm (self regulating system)
Blade, bell and shaft	Length 350 mm - all stainless steel
Removable blade	✓
Removable bell	✓
Removable foot	No
EasyPlug	✓
Dimensions	Length 740 mm, Ø 125 mm
Gross weight	6.4 kg
Accessories	Wall support - Included

Choose your model:



Scan the QR-Code to see the immersion blenders in action.

MP 350 Ultra	Ref.
MP 350 Ultra 220-240V/50-60/1	34800L
MP 350 Ultra 240V/50-60/1	34801L
MP 350 Ultra 120V/60/1	34805L

MP 350 Ultra V.V.	Ref.
MP 350 V.V. Ultra 220-240V/50-60/1	34840L
MP 350 V.V. Ultra 240V/50-60/1	34841L
MP 350 V.V. Ultra 120V/60/1	34845L



Whisk function

MP 350 Combi Ultra

See page 138

Choose your options:

MP 350 Ultra / MP 350 Ultra V.V.		
Options	Ref.	
EasyGrip removable handle	27359	



MP 450 Ultra

Power	500 W
Voltage	Single phase
Speed	9 500 rpm
Blade, bell and shaft	Length 450 mm - all stainless steel
Removable blade	✓
Removable bell	✓
Removable foot	No
EasyPlug	✓
Dimensions	Length 840 mm, Ø 125 mm
Gross weight	6.3 kg
Accessories	Wall support - Included

MP 450 Ultra V.V.

Power	500 W
Voltage	Single phase
Speed	1 500 to 9 000 rpm (self regulating system)
Blade, bell and shaft	Length 450 mm - all stainless steel
Removable blade	✓
Removable bell	✓
Removable foot	No
EasyPlug	✓
Dimensions	Length 840 mm, Ø 125 mm
Gross weight	6.5 kg
Accessories	Wall support - Included

Choose your model:



Scan the QR-Code to see the immersion blenders in action.

MP 450 Ultra	Ref.
MP 450 Ultra 220-240V/50-60/1	34810L
MP 450 Ultra 240V/50-60/1	34811L
MP 450 Ultra 120V/60/1	34815L

MP 450 Ultra V.V.	Ref.
MP 450 V.V. Ultra 220-240V/50-60/1	34850L
MP 450 V.V. Ultra 240V/50-60/1	34851L
MP 450 V.V. Ultra 120V/60/1	34855L



Whisk function

MP 450 Combi Ultra

See page 138

Choose your options:

MP 450 Ultra / MP 450 Ultra V.V.		
Options	Ref.	
EasyGrip removable handle	27359	

IMMERSION BLENDERS



MP 550 Ultra

Power	750 W
Voltage	Single phase
Speed	9 000 rpm
Blade, bell and shaft	Length 550 mm - all stainless steel
Removable blade	✓
Removable bell	✓
Removable foot	No
Second handle	Removable EasyGrip handle
Electronic booster system	No
EasyPlug	✓
Dimensions	Length 940 mm, Ø 125 mm
Gross weight	6.6 kg
Accessories	Wall support - Included



MP 600 Ultra

Power	850 W
Voltage	Single phase
Speed	9 500 rpm
Blade, bell and shaft	Length 600 mm - all stainless steel
Removable blade	✓
Removable bell	✓
Removable foot	No
Second handle	Removable EasyGrip handle
Electronic booster system	No
EasyPlug	✓
Dimensions	Length 980 mm, Ø 125 mm
Gross weight	7.4 kg
Accessories	Wall support - Included



MP 800 Turbo

Power	1 000 W
Voltage	Single phase
Speed	9 500 rpm
Blade, bell and shaft	Length 740 mm - all stainless steel
Removable blade	✓
Removable bell	✓
Removable foot	✓
Second handle	Integrated stainless steel handle
Electronic booster system	✓
EasyPlug	✓
Dimensions	Length 1 130 mm, Ø 125 mm
Gross weight	9.2 kg
Accessories	Wall support - Included

Choose your model:



Scan the QR-Code to see the immersion blenders in action.

MP 550 Ultra	Ref.
MP 550 Ultra 220-240V/50-60/1	34820LH
MP 550 Ultra 240V/50-60/1	34821LH
MP 550 Ultra 120V/60/1	34825LH

MP 600 Ultra	Ref.
MP 600 Ultra 220-240V/50-60/1	34830LH
MP 600 Ultra 240V/50-60/1	34831LH
MP 600 Ultra 120V/60/1	34835LH

MP 800 Turbo	Ref.
MP 800 Turbo 220-240V/50-60/1	34890L
MP 800 Turbo 240V/50-60/1	34891L
MP 800 Turbo 120V/60/1	34895L

COMBI PRODUCT RANGE

The Robot-Coupe whisk attachment available for Mini MP Combi, CMP Combi, MP Combi Ultra and MP FW mixers is designed to emulsify, mix, shell, beat and knead.

POWERFUL

High-strength motor:
+15 % for greater efficiency.

EASY TO OPERATE

Variable speed button easy to use with one hand.

ERGONOMIC

Ergonomic handle for easier grasping.

CONVENIENT

Self regulating speed system for sophisticated preparations.



EMULSIFY



Salad dressing, mayonnaise, sauces, etc.

MIX



Pancake batter, tomato pulp, seasoning, etc.

SHELL



Semolina, rice, wheat, quinoa, etc.

BEAT



Egg whites, chocolate mousse, whipped cream, etc.

KNEAD/MASH



Mashed potatoes, doughnut dough, batter, etc.

INNOVATION



METAL WHISK BOX

HEAVY DUTY

Metal gears inside 2 metal housings to stand up to heavy duty use.

CLEANING

Overmoulded whisks to ensure perfect hygiene.

ERGONOMIC

Fast coupling of whisks to the gearbox and the gearbox to the motor housing for easy assembly and disassembly.



Mini MP 190 Combi

Power	270 W
Voltage	Single phase
Speed	2 000 to 12 500 rpm for mixer function 350 to 1 560 rpm for whisk function
Blade, bell and shaft	Length 190 mm - all stainless steel
Removable blade	✓
Removable bell	✓
Removable foot	✓
Metal whisk box	✓
Dimensions	Total length with tube 485 mm with whisk 550 mm, Ø 78 mm
Gross weight	2.7 kg
Accessories	Wall support - Included



Mini MP 240 Combi

Power	290 W
Voltage	Single phase
Speed	2 000 to 12 500 rpm for mixer function 350 to 1 560 rpm for whisk function
Blade, bell and shaft	Length 240 mm - all stainless steel
Removable blade	✓
Removable bell	✓
Removable foot	✓
Metal whisk box	✓
Dimensions	Total length with tube 535 mm with whisk 550 mm, Ø 78 mm
Gross weight	2.8 kg
Accessories	Wall support - Included

Choose your model:



Scan the QR-Code to see the immersion blenders in action.

Mini MP 190 Combi		Ref.
Mini MP 190 Combi 230V/50/1		34770
Mini MP 190 Combi 230V/50/1 UK plug		34771
Mini MP 190 Combi 220V/60/1		34774
Mini MP 190 Combi 120V/60/1		34775

Mini MP 240 Combi		Ref.
Mini MP 240 Combi 230V/50/1		34780
Mini MP 240 Combi 230V/50/1 UK plug		34781
Mini MP 240 Combi 220V/60/1		34784
Mini MP 240 Combi 120V/60/1		34785

Choose your options:

	Mini MP 190 Combi		Mini MP 240 Combi	
Option	Ref.		Ref.	
Mini MP whisk attachment	27333		27333	



CMP 250 Combi

CMP 300 Combi

Power	310 W
Voltage	Single phase
Speed	2 300 to 9 600 rpm for mixer function, 500 to 1 800 rpm for whisk function with self regulating speed system
Blade, bell and shaft	Length 250 mm - all stainless steel
Removable blade	✓
Removable bell	✓
Removable foot	✓ equipped with a 3-level watertightness system
Metal whisk box	✓
Dimensions	Total length with tube 640 mm with whisk 610 mm, Ø 125 mm
Gross weight	5.6 kg
Accessories	Wall support - Included

Power	350 W
Voltage	Single phase
Speed	2 300 to 9 600 rpm for mixer function, 500 to 1 800 rpm for whisk function with self regulating speed system
Blade, bell and shaft	Length 300 mm - all stainless steel
Removable blade	✓
Removable bell	✓
Removable foot	✓ equipped with a 3-level watertightness system
Metal whisk box	✓
Dimensions	Total length with tube 700 mm with whisk 610 mm, Ø 125 mm
Gross weight	5.7 kg
Accessories	Wall support - Included

Choose your model:



Scan the QR-Code to see the immersion blenders in action.

CMP 250 Combi	Ref.
CMP 250 Combi 230V/50/1	34300B
CMP 250 Combi 230V/50/1 UK plug	34301B
CMP 250 Combi 220V/60/1	34304B
CMP 250 Combi 120V/60/1	34305B

CMP 300 Combi	Ref.
CMP 300 Combi 230V/50/1	34310B
CMP 300 Combi 230V/50/1 UK plug	34311B
CMP 300 Combi 220V/60/1	34314B
CMP 300 Combi 120V/60/1	34315B

Choose your options:

	CMP 250 Combi	CMP 300 Combi
Options	Ref.	Ref.
CMP Combi whisk attachment	27248	27248
Mixer foot	27249	27250

IMMERSION BLENDERS

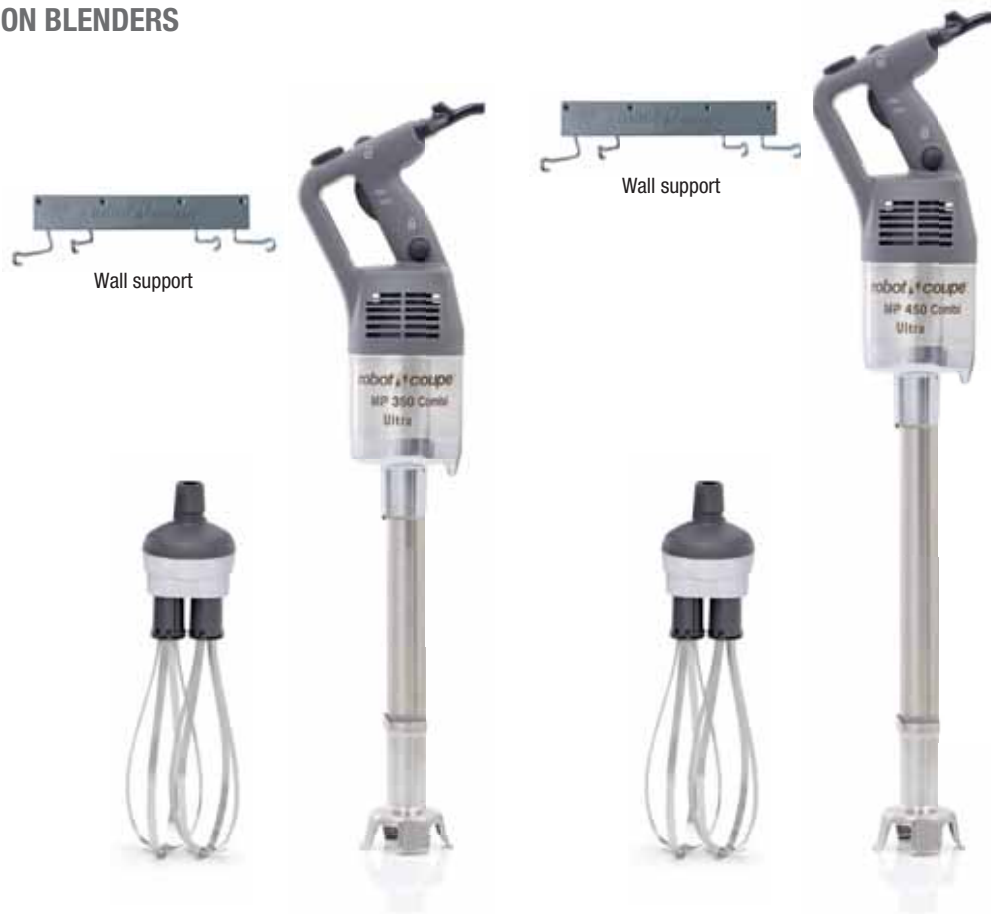

MP 350 Combi Ultra

Power	440 W
Voltage	Single phase
Speed	1 500 to 9 000 rpm for mixer, 250 to 1 500 rpm for whisk with self regulating speed system
Blade, bell and shaft	Length 350 mm - all stainless steel
Removable blade	✓
Removable bell	✓
Removable foot	✓
Metal whisk kit	✓
Detachable whisk	✓
EasyPlug	✓
Dimensions	Total length with tube 790 mm with whisk: 805 mm, Ø 125 mm
Gross weight	7.9 kg
Accessories	Wall support - Included

Choose your model:



Scan the QR-Code to see the immersion blenders in action.

Choose your options:

MP 350 Combi Ultra	Ref.
MP 350 Combi Ultra 220-240V/50-60/1	34860L
MP 350 Combi Ultra 240V/50-60/1	34861L
MP 350 Combi Ultra 120V/60/1	34865L

MP 450 Combi Ultra

Power	500 W
Voltage	Single phase
Speed	1 500 to 9 000 rpm for mixer, 250 to 1 500 rpm for whisk with self regulating speed system
Blade, bell and shaft	Length 450 mm - all stainless steel
Removable blade	✓
Removable bell	✓
Removable foot	✓
Metal whisk kit	✓
Detachable whisk	✓
EasyPlug	✓
Dimensions	Total length with tube 890 mm with whisk 840 mm, Ø 125 mm
Gross weight	8.2 kg
Accessories	Wall support - Included

MP 450 Combi Ultra	Ref.
MP 450 Combi Ultra 220-240V/50-60/1	34870L
MP 450 Combi Ultra 240V/50-60/1	34871L
MP 450 Combi Ultra 120V/60/1	34875L

	MP 350 Combi Ultra	MP 450 Combi Ultra
Options	Ref.	Ref.
MP Combi whisk attachment	27210	27210
Mixing attachment	27355	27355
Mixer foot	39354	39355
EasyGrip removable handle	27359	27359

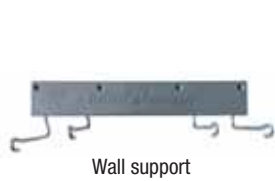

Wall support



MP 450 FW Ultra

Power	500 W
Voltage	Single phase
Speed	250 to 1 500 rpm (self regulating system)
Whisk	280 mm long detachable whisk
Metal whisk box	✓
EasyPlug	✓
Dimensions	Length 800 mm, Ø 125 mm
Gross weight	8.6 kg
Accessories	Wall support - Included

Choose your model:



Scan the QR-Code to see the immersion blenders in action.

MP 450 FW Ultra	Ref.
MP 450 FW Ultra 220-240V/50-60/1	34880L
MP 450 FW Ultra 240V/50-60/1	34881L
MP 450 FW Ultra 120V/60/1	34885L



Wall support



MP 450 XL FW Ultra

Power	500 W
Voltage	Single phase
Speed	150 to 510 rpm (self regulating system)
Whisk	Detachable mixing attachment 690 mm long
Metal whisk box	✓
EasyPlug	✓
Dimensions	Length 1210 mm, Ø 175 mm
Gross weight	8.6 kg
Accessories	Wall support - Included

MP 450 XL FW Ultra	Ref.
MP 450 XL FW Ultra 220-240V/50-60/1	34280L
MP 450 XL FW Ultra 240V/50-60/1	34281L

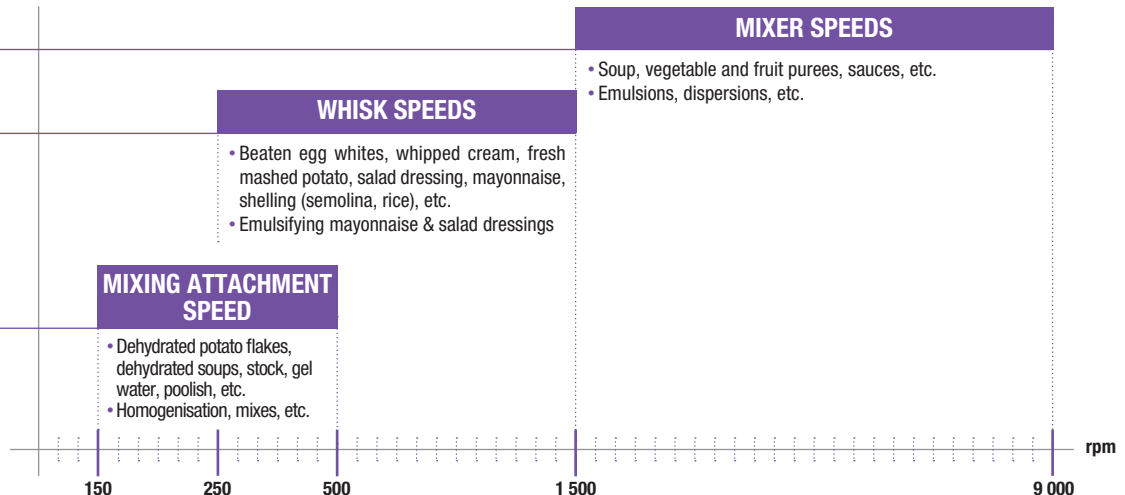

JUICE EXTRACTORS



ULTRA FRESH FRUIT JUICE IN JUST A FEW SECONDS!

Robot Coupe Juice Extractors partner professionals in a wide variety of sectors: bars, restaurants, hotels, institutions and supermarkets.

Quick, efficient and heavy duty with a fast ROI, they provide the ideal solution for making large quantities of ultra fresh fruit and vegetable juices.



JUICE EXTRACTORS

INNOVATION

Ø 79 mm **FEED-HEAD**

For whole fruit and vegetables.



AUTOMATIC FEED TUBE

- With the exclusive automatic feed system, fruit and vegetables are processed effortlessly.
- Fast: 25 cl in just 6 seconds.



BASKET

Two handles for a better grip, can be removed without tools and is easy to clean.

Easy Guide

NEW

Anti-splash spouts in 2 different sizes*:

- 1 Jug / Blender bowl
- 2 Served by the glass



NEW

DRIP TRAY*

Large capacity so the worktop is always clean.



NEW

INCLINED BASE*

For optimum evacuation of juice.

MOTOR

- Quiet so it can be used right in front of the customer.
- 1000 W designed for intensive use throughout the day**



Pulp is ejected under the worktop**

Two ways of using the juicer:



- 1 **Pulp ejected into a container.**
Large capacity translucent pulp collector.

- 2 **Continuous pulp ejection**.**
Pulp ejection chute: continuous pulp ejection directly into a bin under the worktop.



*J 80 Buffet and J 100

**J 100 only

OUR USERS



BARS, RESTAURANTS AND HEALTHCARE FACILITIES

Fresh fruit and vegetable juices are a way of adding a touch of freshness to bar and restaurant menus. They are also highly appreciated in hospitals and retirement homes to prevent residents from being dehydrated.



HOTELS, CANTEENS AND CAFETERIAS

Quiet and easy to operate, Robot-Coupe Juice Extractor provide self-service in hotel breakfast bars and school canteens.



JUICE BARS AND SUPERMARKETS

Especially designed for intensive use, our Juice Extractor range is perfect for the production of large quantities.



Rapid return on investment:

- On average the sale of 500 glasses of juice will write off the cost of a J 100 Juice Extractor.
- Most efficient Juice Extractor on the market for the most frequently used ingredients.

JUICE EXTRACTORS

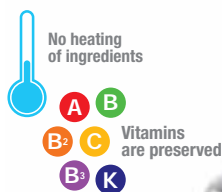

J 80

Induction motor	✓
Power	700 W
Voltage	Single phase
Flow rate	120 L/hr
Bowl	Stainless steel
Feed Hopper	✓ - Automatic Ø 79 mm
Filter	Stainless steel
Grating disc	Stainless steel
Useful height under spout	155 mm
TYPE OF SERVICE: Glass	✓
Jug	✓
Blender bowl	-
No-splash spout	✓ - 1 size
Inclined base	-
Drip catcher tray	✓
Automatic pulp ejection	✓
Translucent pulp collector	6.5 L
Continuous pulp ejection chute	-

Choose your model:



Scan the QR Code to see the Juice Extractor in action.

J 80	Ref.
J 80 230V/50/1	56000B
J 80 230V/50/1 UK plug	56001B
J 80 220V/60/1 DK	56007B
J 80 220V/60/1	56004B
J 80 120V/60/1	56005B

NEW

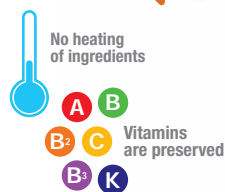

J 80 Buffet

Induction motor	✓
Power	700 W
Voltage	Single phase
Flow rate	120 L/hr
Bowl	Stainless steel
Feed Hopper	✓ - Automatic Ø 79 mm
Filter	Stainless steel
Grating disc	Stainless steel
Useful height under spout	177 mm
TYPE OF SERVICE: Glass	✓
Jug	✓
Blender bowl	-
No-splash spout	✓ - 2 sizes
Inclined base	✓
Drip catcher tray	✓ - Large capacity
Automatic pulp ejection	✓
Translucent pulp collector	6.5 L
Continuous pulp ejection chute	-

Choose your model:

J 80 Buffet	Ref.
J 80 Buffet 230V/50/1	56200B
J 80 Buffet 230V/50/1 UK plug	56201B
J 80 Buffet 220V/60/1 DK	56207B
J 80 Buffet 220V/60/1	56204B
J 80 Buffet 120V/60/1	56205B

Choose your options:

Option	Ref.
Inclined base assembly	49230

J 80 all models

NEW

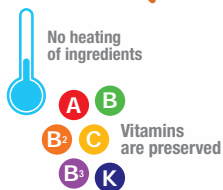

J 100

Induction motor	✓
Power	1 000 W
Voltage	Single phase
Flow rate	160 L/hr
Bowl	Stainless steel
Chute	✓ - Automatic Ø 79 mm
Filter	Stainless steel
Grating disc	Stainless steel - For intensive use
Useful height under spout	251 mm
TYPE OF SERVICE: Glass	✓
Jug	✓
Blender bowl	✓
No-splash spout	✓ - 2 sizes
Inclined base	✓
Drip catcher tray	✓ - Large capacity
Automatic pulp ejection	✓
Translucent pulp collector	7.2 L
Continuous pulp ejection chute	✓

Choose your model:



Scan the QR Code to see the Juice Extractor in action.

	J 100	Ref.
J 100 230V/50/1		56100B
J 100 230V/50/1 UK plug		56101B
J 100 220V/60/1 DK		56107B
J 100 220V/60/1		56104B
J 100 120V/60/1		56105B

J 100

Choose your options:

Option	Ref.
Inclined base assembly	49230



JUICE AND COULIS EXTRACTOR

- Juicing of high-pulp fruit and vegetables.
- Extraction of small amounts of cooked or soft fruit and vegetable coulis.
- Keeps beneficial skin, seeds and fibre.



C 40

Induction motor	✓
Power	500 W
Voltage	230 V single-phase
Speed	1 500 rpm
Flow rate	12 L/hr
Bowl	Composite material

Choose your model:

C 40	Ref.
C 40 230V/50/1	55040
C 40 230V/50/1 UK plug	55041
C 40 220V/60/1	55044
C 40 120V/60/1	55045



Thick tomato juice for
gaspacho and sauces.



Lemon juice for beverages,
sorbets and marinades.



AUTOMATIC SIEVES

Our multi-purpose, heavy duty, automatic sieves are designed to make fruit coulis and pulp, vegetable mousse, stock, fish soups, etc. by separating seeds, stones, fibres and shells without grinding them. The continuous feed system makes it easy to use and a great time saver, especially for homemade dishes.



AUTOMATIC SIEVES

HOPPER

Continuous feeding of washed ingredients that have not been shelled or seeded.

PERFORATED BASKET

The products fall inside the basket where they are centrifuged.

PADDLES

System of paddles rotating at 1 500 rpm, causing the ingredients inside the basket to be separated by centrifugal force.

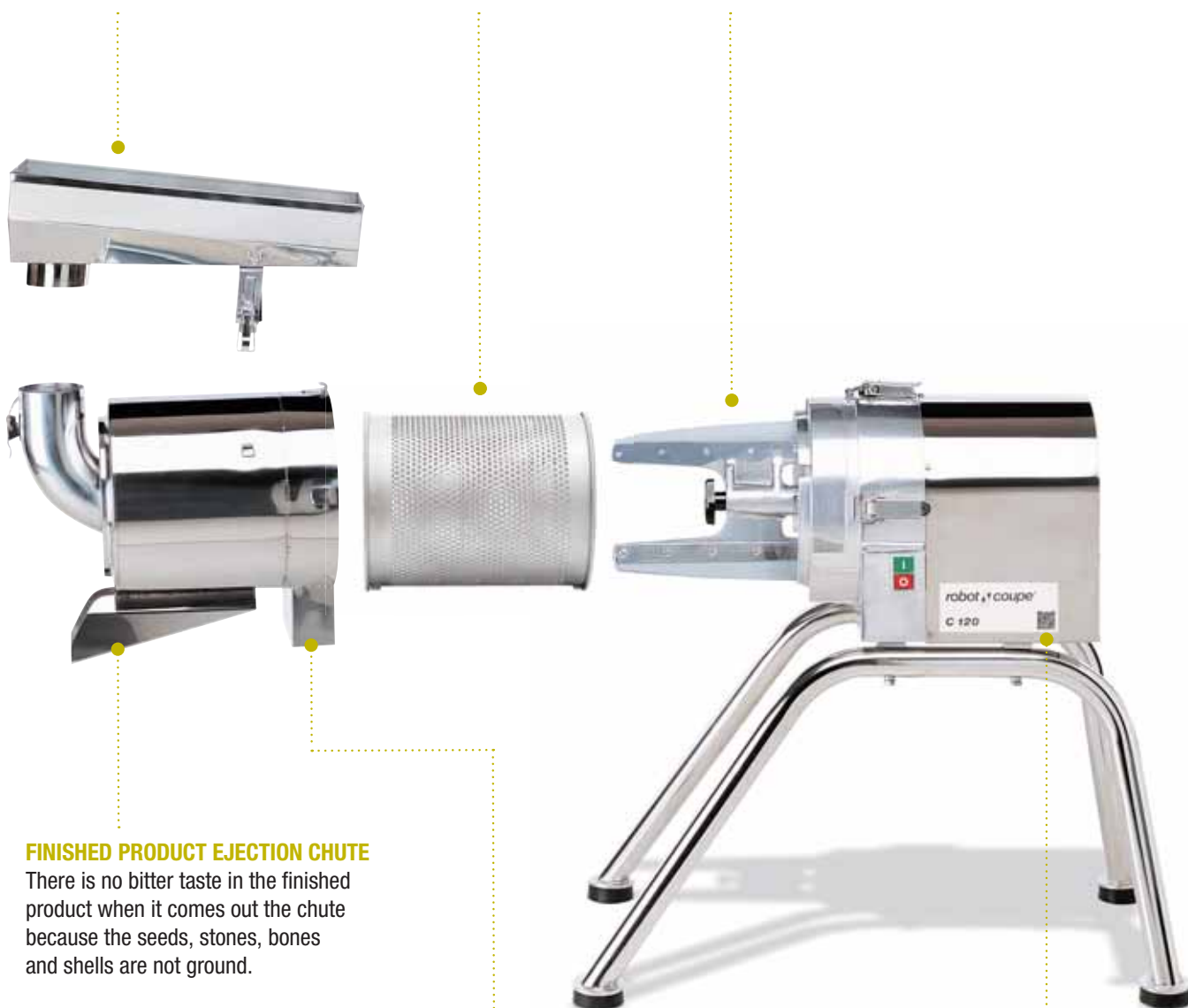

FINISHED PRODUCT EJECTION CHUTE

There is no bitter taste in the finished product when it comes out the chute because the seeds, stones, bones and shells are not ground.

WASTE EJECTION CHUTE

That is, skins, seeds, stones, tails, shells, fibres, etc.

**Easy
Guide**



1 mm
(Standard)



**TOMATO, CAPSICUM,
APPLE COMPOTE, etc.**



FISH AND SHELLFISH SOUP



2 mm



OLIVES



CHERRIES, PLUMS, etc.



3 mm

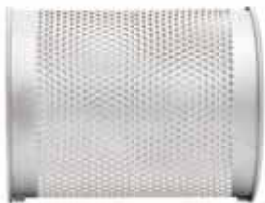

5 mm



APRICOTS



PEACHES, PRUNES, etc.



0.5 mm
To filter fibres and very fine
impurities. Used in addition to
the 1 mm perforated basket.



BERRIES, CHESTNUTS, etc.



**PLANT-BASED BEVERAGES
(COCONUT MILK,
ALMOND MILK, etc.)**

For more applications, contact your Territory Manager.

AUTOMATIC SIEVES



C 80

Induction motor	✓
Power	650 W
Voltage	Single phase
Speed	1 500 rpm
Flow rate	60 kg/hr
Continuous feed	✓
Continuous waste ejection	✓
Motor base	Stainless steel
Bowl	Stainless steel
Feet	-
Hopper	Stainless steel
Table-top model	✓
Floor-standing model	-
Perforated basket	1 mm perforated basket - Included



C 120

Induction motor	✓
Power	900 W
Voltage	Three phase Single phase
Speed	1 500 rpm
Flow rate	120 kg/hr
Continuous feed	✓
Continuous waste ejection	✓
Motor base	Stainless steel
Bowl	Stainless steel
Feet	Stainless steel
Hopper	Stainless steel
Table-top model	-
Floor-standing model	✓
Perforated basket	1 mm perforated basket - Included

Choose your model:



Scan the QR Code to see the automatic sieve in action.

C 80	Ref.
C 80 230V/50/1	55012
C 80 220V/60/1	55017
C 80 115V/60/1	55014

C 120 - Three Phase	Ref.
C 120 230-400V/50/3	55000
C 120 220V/60/3	55009
C 120 - Single Phase	Ref.
C 120 230V/50/1	55011
C 120 115V/60/1	55022

Choose your options:

Options	C 80		C 120	
	Ref.		Ref.	
Perforated basket Ø 0.5 mm	57009		57211	
Perforated basket Ø 1.5 mm	-	-	57042	
Perforated basket Ø 2 mm	-	-	57019	
Perforated basket Ø 3 mm	57008		57156	
Perforated basket Ø 5 mm (on request)	57023		57020	
Additional 1 mm perforated basket	57007		57145	
Additional rubber scraper (per unit)	100338S		100702S	



C 200 Special Industry

C 200 V.V.

Induction motor	✓	✓
Power	1 800 W	1 800 W
Voltage	Three phase	Single phase
Speed	1 500 rpm	100 - 1 800 rpm
Flow rate	150 kg/hr	150 kg/hr
Continuous feed	✓	✓
Continuous waste ejection	✓	✓
Motor base	Stainless steel	Stainless steel
Bowl	Stainless steel	Stainless steel
Feet	Stainless steel	Stainless steel
Hopper	Stainless steel	Stainless steel
Table-top model	-	-
Floor-standing model	✓	✓
Perforated basket	1 mm and 3 mm perforated baskets Included	1 mm and 3 mm perforated baskets Included

Choose your model:

C 200 Special Industry	Ref.	
C 200 Special Industry 230-400V/50/3	55006	
C 200 Special Industry 220V/60/3	55007	

C 200 V.V.	Ref.	
C 200 V.V. 230V/50-60/1	55018	

 It is advisable to use a type A or type B GFCI

Choose your options:

C 200 all models		
Options	Ref.	
Perforated basket Ø 0.5 mm	57211	
Perforated basket Ø 1.5 mm	57042	
Perforated basket Ø 2 mm	57019	
Perforated basket Ø 3 mm	57156	
Perforated basket Ø 5 mm (on request)	57020	
Additional 1 mm perforated basket	57145	
Additional rubber scraper (per unit)	100702S	

TECHNICAL DATA

FOOD PROCESSORS					Dimensions (mm)						Weight (kg)	
Description	Power (w)	Single phase	Three phase	Plug	Machine			Packaging			Net	Gross
					L	D	H	L	D	H		
R 201 XL	550	•		10 A	220	280	555	400	300	540	10	11
R 201 XL Ultra	550	•		10 A	220	280	555	400	300	540	10	11
R 211 XL	550	•		10 A	220	360	505	610	410	570	13	14
R 211 XL Ultra	550	•		10 A	220	360	505	610	410	570	13	14
R 301	650	•		10 A	355	305	570	610	410	570	14	17
R 301 Ultra	650	•		10 A	355	305	570	610	410	570	14	17
R 401	700	•		10 A	320	305	570	610	410	570	18	20
R 402	750	•		10 A	320	305	590	610	410	570	21	23
R 402	750		•	No plug supplied	320	305	590	610	410	570	22	24
R 402 V.V.	1 000	•		10 A	320	305	590	610	410	570	22	23
R 502	900		•	No plug supplied	380	365	670	490	390	650	29	34
R 502 V.V.	1 500	•		15 A	380	365	670	490	390	650	30	35
R 752	1 800		•	No plug supplied	380	365	710	490	390	650	33	38
R 752 V.V.	1 500	•	•	15 A	380	365	710	490	390	650	34	38

VEGETABLE PREPARATION MACHINES					Dimensions (mm)						Weight (kg)	
Description	Power (w)	Single phase	Three phase	Plug	Machine			Packaging			Net	Gross
					L	D	H	L	D	H		
CL 20	400	•		10 A	325	310	570	400	385	610	11	12
CL 40	500	•		10 A	345	330	590	400	385	610	14	15
CL 50 - 1V	550	•		10 A	380	305	595	400	390	640	18	20
CL 50 - 1V	550		•	No plug supplied	380	305	595	400	390	640	18	20
CL 50 Ultra - 1V	550	•		10 A	380	305	595	400	390	640	18	20
CL 50 Ultra - 1V	550		•	No plug supplied	380	305	595	400	390	640	18	20
CL 50 Ultra Pizza	550	•	•	10 A	380	305	595	400	390	640	18	20
CL 50 Gourmet	550	•		10 A	390	340	610	400	390	640	20	22
CL 50 Gourmet	600		•	No plug supplied	390	340	610	400	390	640	20	22
CL 52 - 1V	750	•		10 A	360	340	690	400	390	800	26	28
CL 52 - 1V	750		•	No plug supplied	360	340	690	400	390	800	26	28
CL 55 Pusher Feed-Head	1 100		•	No plug supplied	700	359	1100	1120	785	510	35	54
CL 55 2 Feed-Heads	1 100		•	No plug supplied	865	396	1270	1120	785	510	42	61
CL 60 Pusher Feed-Head	1 500		•	No plug supplied	335	560	1160	1120	800	900	57	83
CL 60 V.V. Pusher Feed-Head	1 500	•		10 A	460	770	1355	1120	800	900	69	95
CL 60 2 Feed-Heads	1 500		•	No plug supplied	460	770	1355	1120	800	900	69	95
CL 60 V.V. 2 Feed-Heads	1 500	•		10 A	460	770	1355	460	770	1355	69	95

CUTTER MIXERS					Dimensions (mm)						Weight (kg)	
Description	Power (w)	Single phase	Three phase	Plug	Machine			Packaging			Net	Gross
					L	D	H	L	D	H		
R 2 B	550	•		10 A	200	280	350	400	300	540	9	11
R 2	550	•		10 A	200	280	350	400	300	540	9	11
R 3 - 1500	650	•		10 A	210	320	400	400	300	540	10	11
R 3 - 3000	650	•		10 A	210	320	400	400	300	540	12	13
R 4 - 2V	900		•	No plug supplied	225	305	440	400	300	540	17	18
R 4 - 1V	700	•		10 A	225	305	440	400	300	540	13	14
R 4 V.V.	1 000	•		10 A	225	305	460	400	300	540	17	18
R 5 - 1V	750	•		10 A	280	365	510	490	390	650	21	23
R 5 - 2V	1 500		•	No plug supplied	280	365	510	490	390	650	21	24
R 5 V.V.	1 500	•		15 A	280	365	510	490	390	650	22	24
R 7	1 500		•	No plug supplied	280	365	540	490	390	650	23	25
R 7 V.V.	1 500	•		15 A	280	365	540	490	390	650	23	26
R 8	2 200		•	No plug supplied	315	545	585	700	470	700	37	45
R 8 V.V.	2 200	•		21 A	315	545	585	700	470	700	38	47
R 10	2 600		•	No plug supplied	345	560	660	700	470	700	42	51
R 10 V.V.	2 600	•		21 A	345	560	660	700	470	700	47	54
R 15	3 000		•	No plug supplied	370	615	680	765	465	780	50	59
R 20	4 400		•	No plug supplied	380	630	760	765	465	780	77	86
R 23	4 500		•	No plug supplied	700	600	1250	800	700	1260	110	142
R 30	5 400		•	No plug supplied	720	600	1250	800	700	1260	126	148
R 45	10 000		•	No plug supplied	760	600	1400	990	690	1400	172	195
R 60	11 000		•	No plug supplied	810	600	1400	990	690	1400	187	212

Robot Cook®					Dimensions (mm)						Weight (kg)	
Description	Power (w)	Single phase	Three phase	Plug	Machine			Packaging			Net	Gross
					L	D	H	L	D	H		
Robot Cook®	1 800	•		10 A	225	340	520	410	310	590	14	16

Blixer®					Dimensions (mm)						Weight (kg)	
Description	Power (w)	Single phase	Three phase	Plug	Machine			Packaging			Net	Gross
					L	D	H	L	D	H		
Blixer® 2	700	•		10 A	210	280	390	400	300	540	10	11
Blixer® 3	750	•		10 A	240	305	445	400	300	540	12	13
Blixer® 4 - 1V	900	•		10 A	240	330	480	400	300	540	14	15
Blixer® 4 - 2V	1 000		•	No plug supplied	240	305	445	400	300	540	14	15
Blixer® 4 V.V.	1 100	•		10 A	240	330	480	400	300	540	16	17
Blixer® 5 - 1V	1 500		•	No plug supplied	280	365	540	490	390	650	21	24
Blixer® 5 - 2V	1 500		•	No plug supplied	280	365	540	490	390	650	21	24
Blixer® 5 V.V.	1 500	•		15 A	280	365	540	490	390	650	22	24
Blixer® 7	1 500		•	No plug supplied	280	365	570	490	390	650	23	25
Blixer® 7 V.V.	1 500	•		15 A	280	365	570	490	390	650	23	25
Blixer® 8	2 200		•	No plug supplied	315	545	605	700	470	800	39	47
Blixer® 8 V.V.	2 200	•		21 A	315	545	605	700	470	800	39	47
Blixer® 10	2 600		•	No plug supplied	315	545	680	700	470	800	42	51
Blixer® 10 V.V.	2 600	•		21 A	315	545	680	700	470	800	42	51
Blixer® 15	3 000		•	No plug supplied	315	545	700	765	465	780	50	59
Blixer® 20	4 400		•	No plug supplied	380	630	780	765	465	780	77	86
Blixer® 23	4 500		•	No plug supplied	700	600	1250	800	700	1260	110	142
Blixer® 30	5 400		•	No plug supplied	720	600	1250	800	700	1260	131	154
Blixer® 45	10 000		•	No plug supplied	760	600	1400	990	690	1400	172	195
Blixer® 60	11 000		•	No plug supplied	810	600	1400	990	690	1400	187	210

TECHNICAL DATA

IMMERSION BLENDERS					Dimensions (mm)						Weight (kg)	
Description	Power (w)	Single phase	Three phase	Plug	Machine			Packaging			Net	Gross
					Ø	H	L	D	H			
MicroMix	220	•		10 A	61	430	435	155	75	1	1	
Mini MP 160 V.V.	240	•		10 A	78	455	455	190	115	1	2	
Mini MP 190 V.V.	270	•		10 A	78	485	455	190	115	2	3	
Mini MP 240 V.V.	290	•		10 A	78	535	455	190	115	2	3	
CMP 250 V.V.	310	•		10 A	94	650	690	230	130	3	4	
CMP 300 V.V.	350	•		10 A	94	660	690	230	130	3	4	
CMP 350 V.V.	400	•		10 A	94	700	690	230	130	4	4	
CMP 400 V.V.	420	•		10 A	94	718	690	230	130	4	4	
MP 350 Ultra	440	•		10 A	125	740	930	275	155	5	7	
MP 350 V.V. Ultra	440	•		10 A	125	740	930	275	155	5	6	
MP 450 Ultra	500	•		10 A	125	840	930	275	155	5	6	
MP 450 V.V. Ultra	500	•		10 A	125	840	930	275	155	5	7	
MP 550 Ultra	750	•		10 A	125	940	930	275	155	5	7	
MP 600 Ultra	850	•		10 A	125	980	930	275	155	6	7	
MP 800 Turbo	1 000	•		10 A	125	1130	695	400	235	7	9	
Mini MP 190 Combi	270	•		10 A	78	485	455	190	115	2	3	
Mini MP 240 Combi	290	•		10 A	78	535	455	190	115	2	3	
CMP 250 Combi	310	•		10 A	125	640	560	345	130	3	6	
CMP 300 Combi	350	•		10 A	125	700	560	345	130	3	6	
MP 350 Combi Ultra	440	•		10 A	125	790	930	275	155	6	8	
MP 450 Combi Ultra	500	•		10 A	125	890	930	275	155	6	8	
MP 450 FW Ultra	500	•		10 A	125	800	930	275	155	6	9	
MP 450 XL FW Ultra	500	•		10 A	175	1210	930	275	155	5	9	

JUICE EXTRACTORS					Dimensions (mm)						Weight (kg)	
Description	Power (w)	Single phase	Three phase	Plug	Machine			Packaging			Net	Gross
					L	D	H	L	D	H		
J 80	700	•		10 A	235	535	500	465	285	530	11	13
J 80 Buffet	700	•		10 A	260	565	595	790	292	535	11	13
J 100	1 000	•		10 A	260	565	630	790	292	530	14	15
C 40	500	•		10 A	240	280	645	400	300	540	10	11

AUTOMATIC SIEVES					Dimensions (mm)						Weight (kg)	
Description	Power (w)	Single phase	Three phase	Plug	Machine			Packaging			Net	Gross
					L	D	H	L	D	H		
C 80	650	•		10 A	610	360	540	665	475	560	17	21
C 120	900		•	No plug supplied	1030	400	860	880	585	885	32	46
C 200	1 800		•	No plug supplied	1030	400	860	880	585	885	40	54
C 200 V.V.	1 800	•		10 A	1030	400	860	880	585	885	45	59

Notes

A series of horizontal dotted lines for writing notes.

TERMS AND CONDITIONS OF SALE

PREAMBLE

Robot-Coupe designs and manufactures top-of-the-range food processors for commercial use, which are distributed both in France and abroad, under conditions which reflect its industrial know-how and the image of its products as high-quality appliances designed in the heart of Burgundy.

Distributing Robot-Coupe products involves providing users with advice, services and warranties consistent with Robot-Coupe's brand image and the high standard of its products.

This is why, in order to market Robot-Coupe products appropriately, distributors must meet a whole series of qualitative criteria, centred around their ability to inform users about the characteristics of Robot-Coupe products, to promote these products effectively, to deliver, install and bring into service any products that are sold, and to provide warranty and after-sales services.

GENERAL POINTS

Article 1 :

The general conditions of sale set out in this document apply to all Robot-Coupe customers.

In accordance with article L441-6 of the French Code of Commercial Law, the general conditions of sale shall constitute the legal basis of negotiations, unless provided otherwise in writing and with Robot-Coupe's consent. They shall prevail over all general or specific conditions of purchase. They cannot be departed from without a specific agreement signed by Robot-Coupe.

Any order placed with Robot-Coupe entails ipso jure the purchaser's acceptance of Robot-Coupe's general conditions of sale.

Any order placed in bad faith or of an abnormal nature shall be refused by Robot-Coupe.

RATES AND PRICE REDUCTIONS

Article 2 :

The prices charged by Robot-Coupe are set out in a basic price list reviewed each year on January 1st and valid for one year. Appliances are invoiced on the basis of the prices in effect on the date of despatch.

DELIVERY PERIODS:

Article 3 :

Delivery periods are given as a guide when the order is taken.

Failure to respect the delivery period shall not entitle the customer to any compensation, penalty or damages. It shall not justify the customer's refusal of a delivery.

Article 4 :

Should despatch be postponed at the distributor's request and with Robot-Coupe's consent, the cost of storing and handling the merchandise may be claimed from the purchaser. These arrangements do not alter the obligation to pay for the merchandise.

SHIPMENT – DELIVERY

Article 5 :

Whatever the merchandise's destination, its mode of shipment and the method of payment for the cost of shipment (carriage free/forward), shipment and all related operations shall be at the risk of the customer, who must inspect the despatched goods upon delivery.

Each delivery has to be inspected when received. Any claim must directly be done directly to the last carrier and Robot-Coupe should be informed.

CLAIMS – RETURNS

Article 6 :

It is up to the customer to inspect the merchandise with respect to quantities and references, and to check whether it matches the invoice description. In order to be valid, any claim must be submitted within eight days of receipt of the merchandise.

Article 7 :

If a product which fails to match the invoice description is brought to Robot-Coupe's attention in accordance with the conditions set out above, it shall be replaced or repaired, but shall not give rise to the payment of damages on whatever grounds.

Article 8 :

No merchandise can be returned without Robot-Coupe's prior permission. Any merchandise that is returned must be in good condition and must never have been used. It must clearly bear the name of the sender.

PAYMENTS

Article 9 :

In accordance with article L 441-6 of the French Code of Commercial Law, failure to pay on the day following the date of payment shown on the invoice shall result in the invoicing of interest on the late payment at the annual rate of 12%.

Furthermore, unless an extension of the deadline has been requested in time and granted by Robot-Coupe, late payment shall result in:

- in the immediate payability of all sums due, whatever their intended mode of payment.
- the payability as damages and as a penalty (within the meaning assigned by article 1229 of the French Civil Code) of compensation equal to 15% of the sums due, in addition to any legal interest and legal costs.
- the payability of a lumpsum fee equal to 40 € for collection costs.
- the payability, of complementary fees if the collection costs incurred are higher than the lumpsum fee. Lastly, if the purchaser has shirked one of his or her obligations on the occasion of previous orders (e.g. late payment), Robot-Coupe reserves the right to cease deliveries to said purchaser, either temporarily or definitively.

WARRANTY

Article 10 :

Merchandise supplied by ROBOT-COUPÉ has a one-year warranty covering the parts against any operating defects arising from manufacturing defects or defects in the material.

This warranty can only be brought into play by the purchaser if the products have been stored, used and maintained in compliance with the instructions for use published by Robot-Coupe.

In particular, this warranty does not cover (non-exhaustive list):

- inadequate supervision or aftercare, or unsuitable storage.
- the product's normal wear and tear.
- alterations to the product which are not in accordance with Robot-Coupe's instructions.
- use that is improper or does not correspond to the purpose of the product.
- an event of force majeure or any other event beyond the seller's control.
- any other cause which does not arise from an action by Robot-Coupe.

In any event, the warranty is strictly limited to the replacement of the faulty parts by Robot-Coupe, to the exclusion of any other form of compensation on whatever grounds.

The repair, alteration or replacement of parts or products during the period covered by the warranty shall not have the effect of extending said warranty.

Article 11 :

As the retailer is contractually bound to the end customer, the former shall be the primary point of contact should a claim be submitted against the manufacturer's warranty.

The services relating to the implementation of the warranty (administrative and logistic management) are related to and inseparable from the sales contract entered into by the retailer and the end customer.

The sale price invoiced to the end customer comprises not only the price of the finished products being sold but also the retailer's consideration for managing the warranty covering these products.

As such, Robot-Coupe shall not bear any of the direct or indirect expenses incurred by the retailers in administering the manufacturer's warranty.

RESERVATION OF TITLE

Article 12 :

ROBOT-COUPÉ reserves title to merchandise sold until the latter's prices have been paid in full, both interest and principal. Should the purchaser fail to pay the price on the due date, Robot-Coupe shall be entitled to recover the products, the sale shall be cancelled de jure if Robot-Coupe so wishes and the latter shall keep any downpayments that have already been made in return for the use the purchaser has made of the products.

Should the parties disagree as to the conditions under which the merchandise is to be returned, said return of goods shall be obtained by summary order injunction delivered by the presiding judge of Créteil Commercial Court to which the parties expressly assign competence.

Transfer of risk :

Robot-Coupe shall reserve title to the merchandise until the latter's prices have been paid in full, but the purchaser shall become responsible for it as soon as it has been materially handed over to the latter, the transfer of possession entailing the transfer of risk. As a consequence, the purchaser agrees to take out an insurance policy covering the loss, theft or destruction of the relevant merchandise.

Resale :

As Robot-Coupe shall reserve title to the merchandise until its price has been paid in full, the purchaser is expressly forbidden to use it for the purposes of resale.

However, Robot-Coupe, as a tolerance and a business expedient, authorizes the purchaser to resell the merchandise, providing that the purchaser settles all outstanding sums immediately upon resale, the corresponding sums being hypothecated here and now for the benefit of Robot-Coupe in accordance with article 2071 of the French Civil Code, the purchaser becoming merely the trustee of the price.

Shipment or warehousing :

Should the purchaser be required to transfer the products to a carrier or an agent, the latter shall date and sign a document mentioning the references and quantities of the merchandise of which he or she is taking possession and add in his or her own handwriting the words "I confirm that when the merchandise was handed over to me I read the clause stipulating that Robot-Coupe reserves title to this merchandise".

Seizure or requisition :

Until such time as the price is paid in full, the customer shall be obliged to inform Robot-Coupe, within twenty-four hours, of the seizure, requisition or confiscation of the merchandise for the benefit of a third party and to take all steps to ensure that Robot-Coupe's title is recognized and respected in the event of action by creditors.

Receivership or liquidation :

In the event of receivership or the liquidation of the purchaser's property, and in accordance with the provisions of article L 621-115 of the French Code of Commercial Law, Robot-Coupe shall be permitted to claim this merchandise within three months following the publication of the court order setting the procedure in motion.

USE OF THE ROBOT-COUPÉ TRADEMARK AND OTHER INTELLECTUAL PROPERTY RIGHTS

Article 13 :

Apart from the sales contract, the retailer is forbidden to use the Robot-Coupe trademark and more generally any elements which might carry Robot-Coupe's intellectual property rights (photos of the products or advertising images, texts of recipe books and other texts, etc.) without Robot-Coupe's prior written permission.

In particular, any advertisement using the Robot-Coupe trademark either as the main subject or as an accessory shall be brought to Robot-Coupe's attention and shall be subject to the latter's prior written permission.

WASTE ELECTRICAL AND ELECTRONIC EQUIPMENT (WEEE)

Article 14 :

Insofar as the equipment being sold is electrical or electronic equipment as defined by decree no. 2005-829 of 20 July 2005, transposing the European directive 2002-96-CE of 27 January 2003, it is hereby agreed that the purchaser in possession of this equipment shall, unless it is expressly agreed otherwise, organize and pay for the disposal of the waste equipment, under the conditions set out in sections 21 and 22 of the aforementioned decree.

In the event of an inspection, the manufacturer can ask the purchaser to supply documents proving that the latter has fulfilled all the obligations relating to the equipment which was transferred to him or her under the sales contract.

Should the purchaser fail to supply these documents, the purchaser shall be assumed to be responsible for failing to fulfil his or her obligations, in respect of which the manufacturer reserves the right to claim damages.

CLAIMS

Article 15 :

From the date on which these general conditions take effect, no claim concerning a price advantage or a service shall be allowed if it is submitted more than twelve months after the start of the debt.

FORCE MAJEURE

Article 16 :

The advent of a force majeure shall have the effect of suspending the fulfilment of these contractual obligations.

A case of force majeure is any event beyond Robot-Coupe's control and which prevents it from operating properly during the manufacture or dispatch of the merchandise.

Cases of force majeure include floods, fires, total or partial strikes hindering the normal operation of Robot-Coupe or one of its suppliers, subcontractors or carriers, as well as an interruption of transport or the supply of power, raw materials or spare parts.

Article 17 :

Robot-Coupe reserves the right to make any alteration to the products described in its catalogues and other advertising media.

DISPUTES

Article 18 :

All sales entered into by Robot-Coupe are governed by French law.

All disputes relating to sales by Robot-Coupe and the application or interpretation of these general conditions of sale shall be heard exclusively by Créteil Commercial Court.



robot  coupe[®]

**Made in France by ROBOT-COUCPE s.n.c.
Head Office, French, Export and Marketing Department:**

Tel.: + 33 1 43 98 88 33

48, rue des Vignerons - 94300 Vincennes - France

Email: international@robot-coupe.com

robot-coupe.com